

PERFORMANCE  
MADE  
SMARTER

Product manual

**9106**

**HART transparent repeater**



Segurança  
**INMETRO**



**ClassNK**  
APPROVED



**EAC**



TEMPERATURE | I.S. INTERFACES | COMMUNICATION INTERFACES | MULTIFUNCTIONAL | ISOLATION | DISPLAY

No. 9106V106-UK  
Product version: 9106-002

**PR**  
electronics

# 6 Product Pillars

## *to meet your every need*

### Individually outstanding, unrivalled in combination

With our innovative, patented technologies, we make signal conditioning smarter and simpler. Our portfolio is composed of six product areas, where we offer a wide range of analog and digital devices covering over a thousand applications in industrial and factory automation. All our products comply with or surpass the highest industry standards, ensuring reliability in even the harshest of environments and have a 5-year warranty for greater peace of mind.



Temperature

Our range of temperature transmitters and sensors provides the highest level of signal integrity from the measurement point to your control system. You can convert industrial process temperature signals to analog, bus or digital communications using a highly reliable point-to-point solution with a fast response time, automatic self-calibration, sensor error detection, low drift, and top EMC performance in any environment.



I.S. Interface

We deliver the safest signals by validating our products against the toughest safety standards. Through our commitment to innovation, we have made pioneering achievements in developing I.S. interfaces with SIL 2 Full Assessment that are both efficient and cost-effective. Our comprehensive range of analog and digital intrinsically safe isolation barriers offers multifunctional inputs and outputs, making PR an easy-to-implement site standard. Our backplanes further simplify large installations and provide seamless integration to standard DCS systems.



Communication

We provide inexpensive, easy-to-use, future-ready communication interfaces that can access your PR installed base of products. All the interfaces are detachable, have a built-in display for readout of process values and diagnostics, and can be configured via push-buttons. Product specific functionality includes communication via Modbus and Bluetooth and remote access using our PR Process Supervisor (PPS) application, available for iOS and Android.



Multifunction

Our unique range of single devices covering multiple applications is easily deployable as your site standard. Having one variant that applies to a broad range of applications can reduce your installation time and training, and greatly simplify spare parts management at your facilities. Our devices are designed for long-term signal accuracy, low power consumption, immunity to electrical noise and simple programming.



Isolation

Our compact, fast, high-quality 6 mm isolators are based on microprocessor technology to provide exceptional performance and EMC-immunity for dedicated applications at a very low total cost of ownership. They can be stacked both vertically and horizontally with no air gap separation between units required.



Display

Our display range is characterized by its flexibility and stability. The devices meet nearly every demand for display readout of process signals, and have universal input and power supply capabilities. They provide a real-time measurement of your process value no matter the industry, and are engineered to provide a user-friendly and reliable relay of information, even in demanding environments.

# HART TRANSPARENT REPEATER

## 9106

### Table of contents

Warning .....	4
Symbol identification .....	4
Safety instructions .....	4
How to demount system 9000 .....	5
Application .....	6
Advanced features .....	6
Technical characteristics .....	6
Applications - 9106Axxx .....	7
Applications - 9106Bxxx .....	8
PR 45xx display / programming front .....	9
Using Modbus output via 4511 .....	9
Mounting / demounting the PR 45xx .....	9
Order .....	10
Accessories .....	10
Technical data .....	10
Visualisation in 45xx of hardware / software error .....	13
Connections .....	14
Block diagram .....	15
Signal error indications without display front .....	16
Configuration / operating the function keys .....	17
Routing diagram .....	18
Routing diagram, advanced settings (ADV.SET) .....	19
Help text overview .....	20
IECEX Installation Drawing .....	21
ATEX Installation Drawing .....	26
FM Installation Drawing .....	31
UL Installation Drawing .....	36
Desenho de instalação INMETRO .....	44
Document history .....	49

## Warning



The following operations should only be carried out on a disconnected device and under ESD-safe conditions:

- General mounting, wire connection and disconnection.
- Troubleshooting the device.

**Repair of the device and replacement of circuit breakers must be done by PR electronics A/S only.**

## Warning



Do not open the front plate of the device as this will cause damage to the connector for the display / programming front PR 45xx.

This device contains no DIP-switches or jumpers.

## Symbol identification



**Triangle with an exclamation mark:** Read the manual before installation and commissioning of the device in order to avoid incidents that could lead to personal injury or mechanical damage. Warning/demand. Potentially lethal situations.



**The CE mark** proves the compliance of the device with the essential requirements of the directives.



**The double insulation symbol** shows that the device is protected by double or reinforced insulation.



**Ex devices** have been approved acc. to the ATEX directive for use in connection with installations in explosive areas. See installation drawings in appendix.

## Safety instructions

### Definitions

**Hazardous voltages** have been defined as the ranges: 75 to 1500 Volt DC, and 50 to 1000 Volt AC.

**Technicians** are qualified persons educated or trained to mount, operate, and also trouble-shoot technically correct and in accordance with safety regulations.

**Operators**, being familiar with the contents of this manual, adjust and operate the knobs or potentiometers during normal operation.

### Receipt and unpacking

Unpack the device without damaging it and check whether the device type corresponds to the one ordered. The packing should always follow the device until this has been permanently mounted.

### Environment

Avoid direct sun light, dust, high temperatures, mechanical vibrations and shock, and rain and heavy moisture. If necessary, heating in excess of the stated limits for ambient temperatures should be avoided by way of ventilation.

The device must be installed in pollution degree 2 or better.

The device is designed to be safe at least under an altitude up to 2 000 m.

## Mounting

Only technicians, who are familiar with the technical terms, warnings, and instructions in the manual and who are able to follow these, should connect the device. Should there be any doubt as to the correct handling of the device, please contact your local distributor or, alternatively,

**PR electronics A/S**  
**www.prelectronics.com**

The use of stranded wires is not permitted for mains wiring except when wires are fitted with cable ends.

Descriptions of input / output and supply connections are shown in the block diagram and on the side label.

The device is provided with field wiring terminals and shall be supplied from a Power Supply having double / reinforced insulation. A power switch shall be easily accessible and close to the device. The power switch shall be marked as the disconnecting unit for the device.

For installation on Power Rail 9400 the power is supplied by Power Control Unit 9410.

Year of manufacture can be taken from the first two digits in the serial number.

## Calibration and Adjustment

During calibration and adjustment, the measuring and connection of external voltages must be carried out according to the specifications of this manual. The technician must use tools and instruments that are safe to use.

## Normal operation

Operators are only allowed to adjust and operate devices that are safely fixed in panels, etc., thus avoiding the danger of personal injury and damage. This means there is no electrical shock hazard, and the device is easily accessible.

## Cleaning

When disconnected, the device may be cleaned with a cloth moistened with distilled water.

## Liability

To the extent the instructions in this manual are not strictly observed, the customer cannot advance a demand against PR electronics A/S that would otherwise exist according to the concluded sales agreement.

## How to demount system 9000

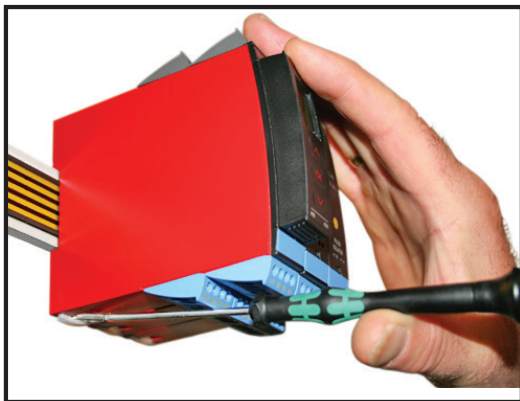

**Picture 1:**

By lifting the bottom lock, the device is detached from the DIN rail.

# HART TRANSPARENT REPEATER 9106

- 24 VDC supply via power rail or connectors
- Active and passive mA input
- Active or passive output via the same two terminals
- Splitter function - 1 in and 2 out
- SIL2 / SIL3 Full Assessment and certified acc. to IEC 61508

## Application

- 9106 is a 1- or 2-channel isolated 1:1 repeater barrier.
- The device supplies 2-wire SMART transmitters and can also be used for 2-wire SMART current sources. HART & BRAIN protocols are supported and are transferred bi-directionally.
- 9106Axxx can be mounted in the safe area or in zone 2 / Class I, Division 2, Groups A, B, C, D.
- 9106Bxxx can be mounted in the safe area or in zone 2 / Class 1, Division 2 and receive signals from zone 0, 1, 2 and zone 20, 21, 22 including mining / Class I/II/III, Division 1, Gr. A-G.
- The PR 45xx displays the process value for each channel and can be used to define high and low limits for detection of loop current level. If these limits are exceeded, the status relay will activate.
- In the 1-channel version the status relay can be used as a simple limit switch.
- For duplication/migration purposes, the outputs can be sent to two different DCS/PLC/HMI or any monitoring system.
- In safety applications (SIL loops), the 9106xxBx can be used as a splitter with the following output configuration:
  - When using 9106xxBx in a SIL2 safety function, channel 1 is used for the safety loop. Channel 2 can be used for any non-safety device.
  - For higher safety purposes (SIL 3), 9106xxBx can be used as a splitter for SIL 3 loops. Channel 1 and 2 are then connected to the same safety PLC, where channel 2 is used as a redundant diagnostic channel. (For more information, consult the FMEDA Report and the Safety Manual).

## Advanced features

- The PR 45xx detachable display and the green and red front LEDs indicate operation status for each channel.
- A tag number can be defined for each channel.
- Monitoring of error events and cable breakage on input via the individual status relay and/or a collective electronic signal via the power rail.
- Suitable for the use in systems up to Performance Level "d" according to ISO-13849.

## Technical characteristics

- High galvanic isolation of 2.6 kVAC.
- Fast response time <5 msec.
- High accuracy better than 0.1%.
- 2-wire transmitter supply >16 V.

# Applications - 9106Axxx

Input signals:

Output signals:

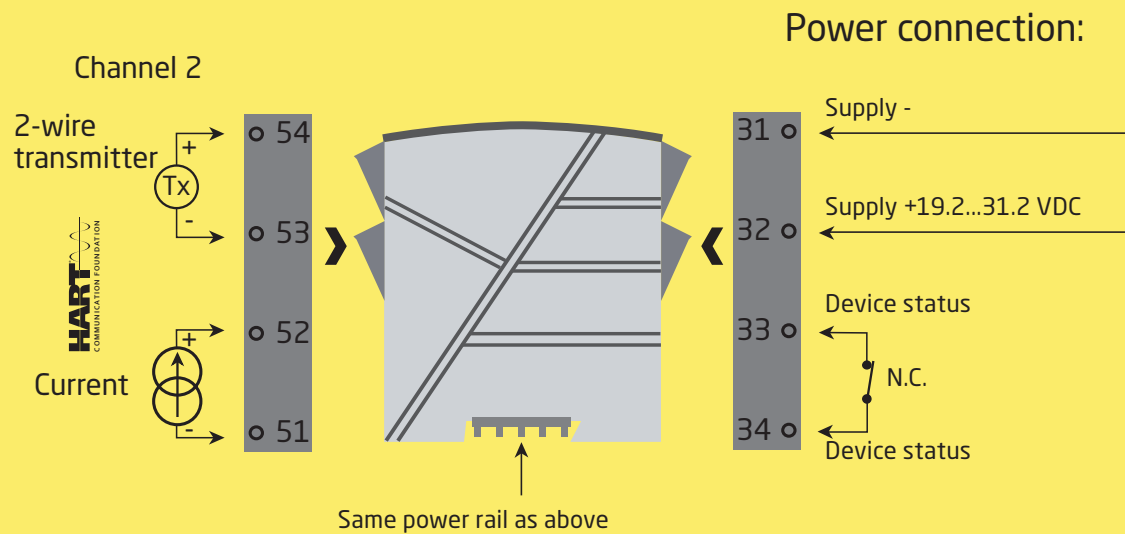
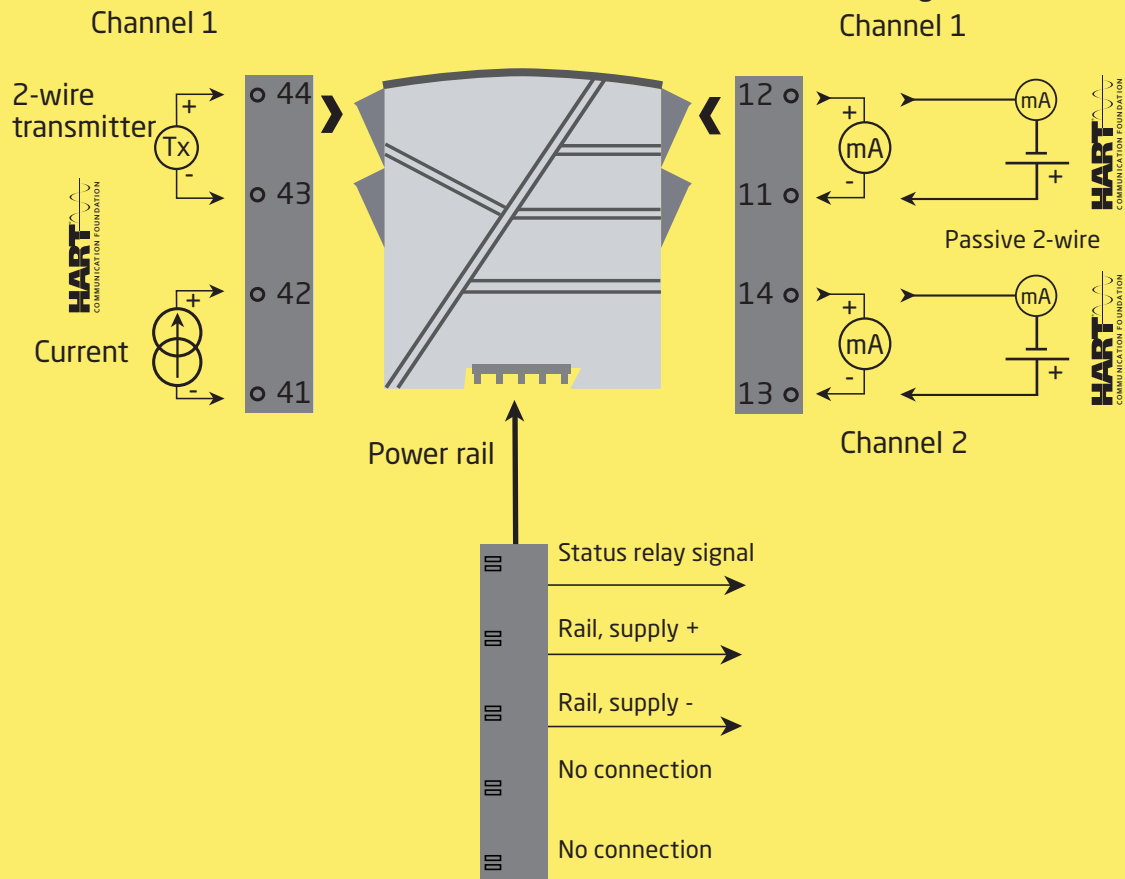

**Zone 2 & Cl. 1, Div. 2, gr. A-D  
or Safe Area**



# Applications - 9106Bxxx

## Input signals:

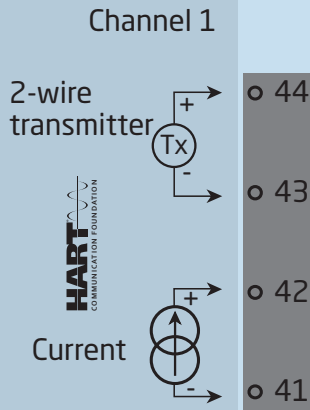

## Output signals:

Analog, 4...20 mA  
Channel 1

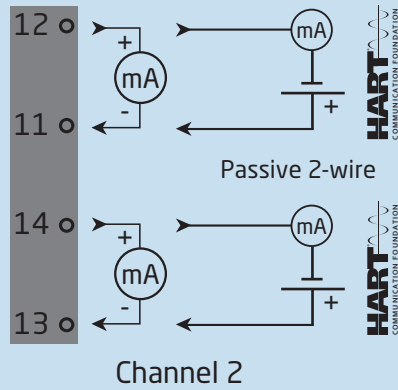

Power rail

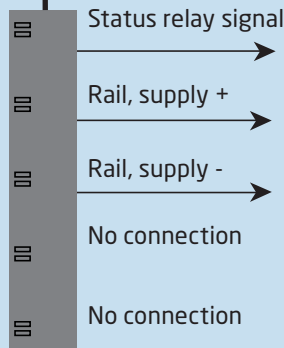

Channel 2

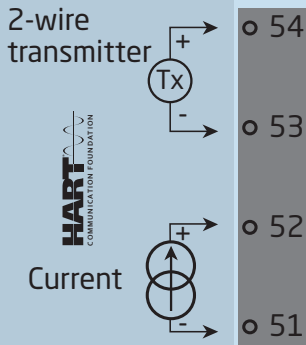

## Power connection:

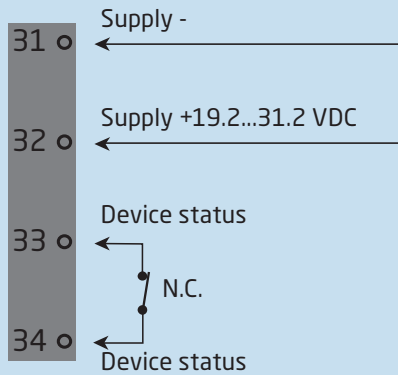

Same power rail as above

**Zone 0, 1, 2,  
20, 21, 22, M1 &  
Cl. I/II/III, Div. 1  
gr. A-G**

**Zone 2 & Cl. 1, Div. 2, gr. A-D  
or Safe Area**



## PR 45xx display / programming front



### Functionality

The simple and easily understandable menu structure and the explanatory help texts guide you effortlessly and automatically through the configuration steps, thus making the product very easy to use. Functions and configuration options are described in the section "Configuration / operating the function keys".

### Application

- Communications interface for modification of operational parameters in 9106.
- When mounted in the process, the display shows process values and device status.

### Technical characteristics

- LCD display with 4 lines:
  - Line 1 (H=5.57 mm) shows status for each channel (OK or error).
  - Line 2 (H=3.33 mm) shows loop current in mA for channel 1 or tag no.
  - Line 3 (H=3.33 mm) shows loop current in mA for channel 2 or tag no.
  - Line 4 shows communications status.
- In order to protect the configuration against unauthorised changes, access to the menus can be blocked by a password.

## Using Modbus output via 4511

When using the digital output of the 4511 and no load on the output terminals of the 9106, the output terminals need to be shorted to make sure that the 9106 does not overheat.

A short-circuit bridge will be mounted from factory, but only when you order the part together with the 9106. Remember to order 2 short-circuit bridges if you order the 2-channel version of 9106.

## Mounting / demounting the PR 45xx

- 1: Insert the tabs of the PR 45xx into the holes at the top of the device.
- 2: Hinge the PR 45xx down until it snaps into place.

### Demounting of the PR 45xx

- 3: Push the release button on the bottom of the PR 45xx and hinge the the PR 45xx out and up.
- 4: With the PR 45xx hinged up, remove from holes at the top of the device.

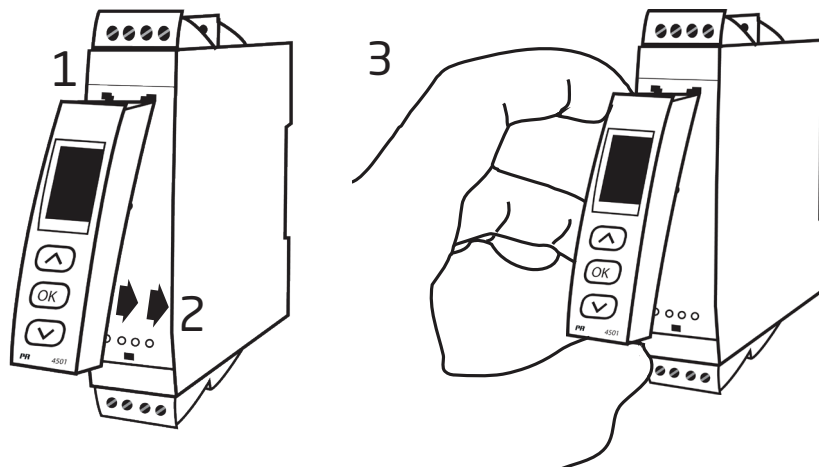

## Order

Type	Associated apparatus	Barrier version	Unit channels	I.S. / Ex approvals
9106	No : A	U <sub>o</sub> = 27.5 V :1	Single : A	ATEX, IECEx, FM, : - INMETRO, EAC-Ex
	Yes : B	U <sub>o</sub> = 25.3 V :2	Double : B	
				cULus, ATEX, IECEx, : -U9 FM, INMETRO, EAC-Ex

**Example: 9106B2B**

## Accessories

- 4501** = Display / programming front
- 4511** = Communication enabler
- ST9106-01** = Short-circuit bridge for 9106 output
- 9400** = Power rail
- 9404** = Module stop for rail
- 9410** = Power control unit
- 9421** = Power supply 24 V - Ex nA nC

## Technical data

### Environmental conditions

Specifications range . . . . .	-20°C to +60°C
Storage temperature . . . . .	-20°C to +85°C
Calibration temperature . . . . .	20...28°C
Relative humidity . . . . .	< 95% RH (non-cond.)
Protection degree . . . . .	IP20
Installation in . . . . .	Pollution degree 2 & overvoltage category II.

### Mechanical specifications

Dimensions (HxWxD) . . . . .	109 x 23.5 x 104 mm
Dimensions (HxWxD) w/ 4501 / 451x . . . . .	109 x 23.5 x 116 / 131 mm
Weight approx. . . . .	250 g
Weight incl. 4501 / 451x (approx.) . . . . .	265 g / 280 g
DIN rail type. . . . .	DIN EN 60715 - 35 mm
Wire size. . . . .	0.13...2.08 mm <sup>2</sup> / AWG 26...14 stranded wire
Screw terminal torque. . . . .	0.5 Nm
Vibration. . . . .	IEC 60068-2-6
2...13.2 Hz . . . . .	±1 mm
13.2...100 Hz. . . . .	±0.7 g

### Common electrical specifications

Supply voltage . . . . .	19.2...31.2 VDC
Fuse . . . . .	1.25 A SB / 250 VAC

Type	Description	Max. power dissipation	Max. required power
Passive input			
9106x1Ax	1 ch. (Ex Uo 27.5 V)	≤ 0.8 W	≤ 1.1 W
9106x1Bx	2 ch. (Ex Uo 27.5 V)	≤ 1.2 W	≤ 1.9 W
9106B2Ax	1 ch. (Ex Uo 25.3 V)	≤ 0.8 W	≤ 1.1 W
9106x2Bx	2 ch. (Ex Uo 25.3 V)	≤ 1.2 W	≤ 1.9 W
Active input			
9106x1Ax	1 ch. (Ex Uo 27.5 V)	≤ 1.1 W	≤ 1.1 W
9106x1Bx	2 ch. (Ex Uo 27.5 V)	≤ 1.9 W	≤ 1.9 W
9106x2Ax	1 ch. (Ex Uo 25.3 V)	≤ 1.1 W	≤ 1.1 W
9106x2Bx	2 ch. (Ex Uo 25.3 V)	≤ 1.9 W	≤ 1.9 W

Max. required power is the maximum power needed at terminals 31 and 32.

Max. power dissipation is the maximum power dissipated by the device.

If the 9106 is used with the 45xx, then add 40 mW to the max. power dissipation and 70 mW to the max. required power for each device with the 45xx.

**Isolation - test / working:**

- Input to any. . . . . 2.6 kVAC / 300 VAC reinforced isolation
- Analog output to supply . . . . . 2.6 kVAC / 300 VAC reinforced isolation
- Status relay to supply . . . . . 1.5 kVAC / 150 VAC reinforced isolation
- Programming . . . . . PR 45xx
- Signal dynamics, input /output . . . . . Analog signal chain
- SMART bi-directional communication frequency range . . . . . 0.5...7.5 kHz
- Signal / noise ratio. . . . . > 60 dB
- Response time (0...90%, 100...10%) . . . . . < 5 ms
- Effect of supply voltage change on output (nom. 24 VDC) . . . . . < ±10 µA

Accuracy values		
Input type	Absolute accuracy	Temperature coefficient
mA	≤ ±16	≤ ±1.6 µA /

EMC - immunity influence. . . . .	< ±0.5% of span
Extended EMC immunity:	
NAMUR NE 21, A criterion, burst . . . . .	< ±1% of span

**Current input**

- Measurement range . . . . . 3.5...23 mA
- 2-wire transmitter supply (terminal 44...43 and 54...53):
- 9106x1xx (Uo=27.5 VDC) . . . . . >16 V / 20 mA
- 9106x2xx (Uo=25.3 VDC) . . . . . >15 V / 20 mA
- Sensor error detection:
- Loop break 4...20 mA . . . . . < 1 mA
- Input voltage drop:
- Supplied unit . . . . . < 4 V @ 23 mA
- Non-supplied unit . . . . . < 6 V @ 23 mA

## Ex barrier data

9106B1xx: . . . . .	Uo = 27.5 V
	Io = 92.6 mA
	Po = 0.64 W
9106B2xx: . . . . .	Uo = 25.3 V
	Io = 96 mA
	Po = 0.61 W

## Current output

Signal range. . . . .	3.5...23 mA
Load . . . . .	≤ 600 Ω
Load stability . . . . .	≤ 0.01% of span / 100 Ω
Current limit. . . . .	≤ 28 mA

## Passive 2-wire output installation

Max. external 2-wire supply . . . . .	26 VDC
Max. load resistance [Ω]. . . . .	(Vsupply - 3.5) / 0.023 A
Effect of external 2-wire supply voltage variation . . . . .	< 0.005% of span / V

of span = normal measurement range 4...20 mA

## Status relay output terminal 33-34

Relay function . . . . .	N.C.
Programmable low setpoint . . . . .	0...29.9 mA
Programmable high setpoint . . . . .	0...29.9 mA
Hysteresis for setpoints . . . . .	0.1 mA
Max. voltage . . . . .	110 VDC / 125 VAC
Max. current. . . . .	0.3 ADC / 0.5 AAC
Max. voltage - hazardous installation. . . . .	32 VDC / 32 VAC
Max. current - hazardous installation. . . . .	1 ADC / 0.5 AAC

## Observed authority requirements

EMC. . . . .	2014/30/EU
LVD . . . . .	2014/35/EU
ATEX . . . . .	2014/34/EU
RoHS . . . . .	2011/65/EU

## Approvals

Det Norske Veritas, Marine . . . . .	TAA00000JD
ClassNK . . . . .	TA18527M
c UL us, UL 61010-1. . . . .	E314307
EAC LVD . . . . .	TR-CU 004/2011
EAC . . . . .	TR-CU 020/2011
EAC Ex . . . . .	TR-CU 012/2011

## I.S. / Ex approvals

ATEX . . . . .	PR 14ATEX0101X / DEKRA 11ATEX0244X
IECEX. . . . .	DEK 11.0084X
c FM us. . . . .	FM16US0465X / FM16CA0213X
INMETRO . . . . .	DEKRA 16.0001X
c UL us, UL 913 (only 9106xxx-U9) . . . . .	E233311
EAC Ex . . . . .	RU C-DK.HA65.B.00355/19

## Functional Safety:

SIL2 Certified & Fully Assessed acc. to IEC 61508  
SFF> 60% - type A component  
SIL3 Applicable through redundant structure (HFT=0)

## Visualisation in 45xx of hardware / software error

Readout at hardware error		
Error search	Readout	Cause
Communications test 45xx and 9106	NO.CO	Connection error
EEprom error - check configuration	FL.ER	Configuration error or CRC mismatch, recovery configuration is loaded
User error	II!/II!	Loop limit exceeded
User error	II!/II!	Loop error
EEprom error - check configuration	EE.ER / IE.ER	Invalid configuration (CRC or data)
Hardware error	SU.ER	Supply error
Hardware error	RA.ER	RAM error
Hardware error	FL.ER	Flash error
Hardware error	IN.ER	Initialization error
Hardware error	C1.ER	Hardware error - channel 1
Hardware error	C2.ER	Hardware error - channel 2
Hardware error	DE.ER	General error

! All error indications in the display flash once per second. The help text explains the error.  
In case of cable fault the backlight also flashes. This can be reset by pressing the  key.

Errors affecting both channels are shown as error on channel 1 - and the line showing channel 2 is blank.

Hardware error can be reset in two ways. Either step through the menus (if the other channel is to stay in operation) or power cycle the device.

# Connections

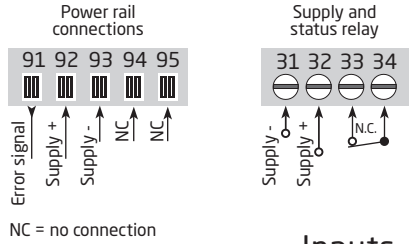

## Inputs - SIL 2:

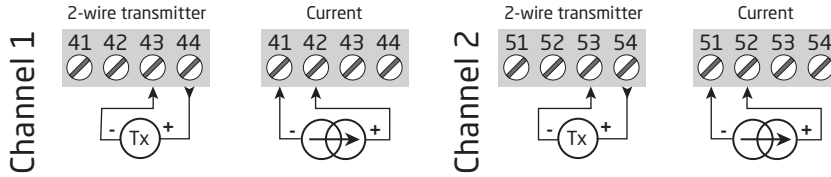

## Inputs - SIL 3:

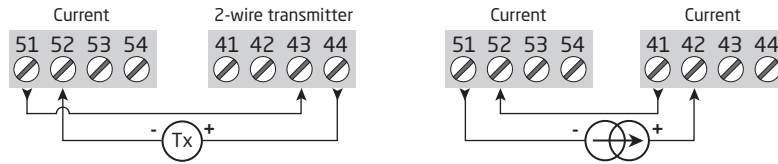

## Outputs:

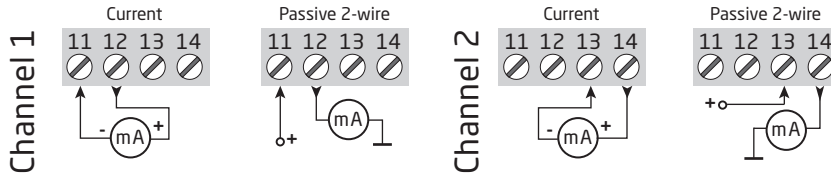

HART communication is possible directly on the input and output terminals if the output load impedance is > 250 Ohm & < 600 Ohm.

# Block diagram

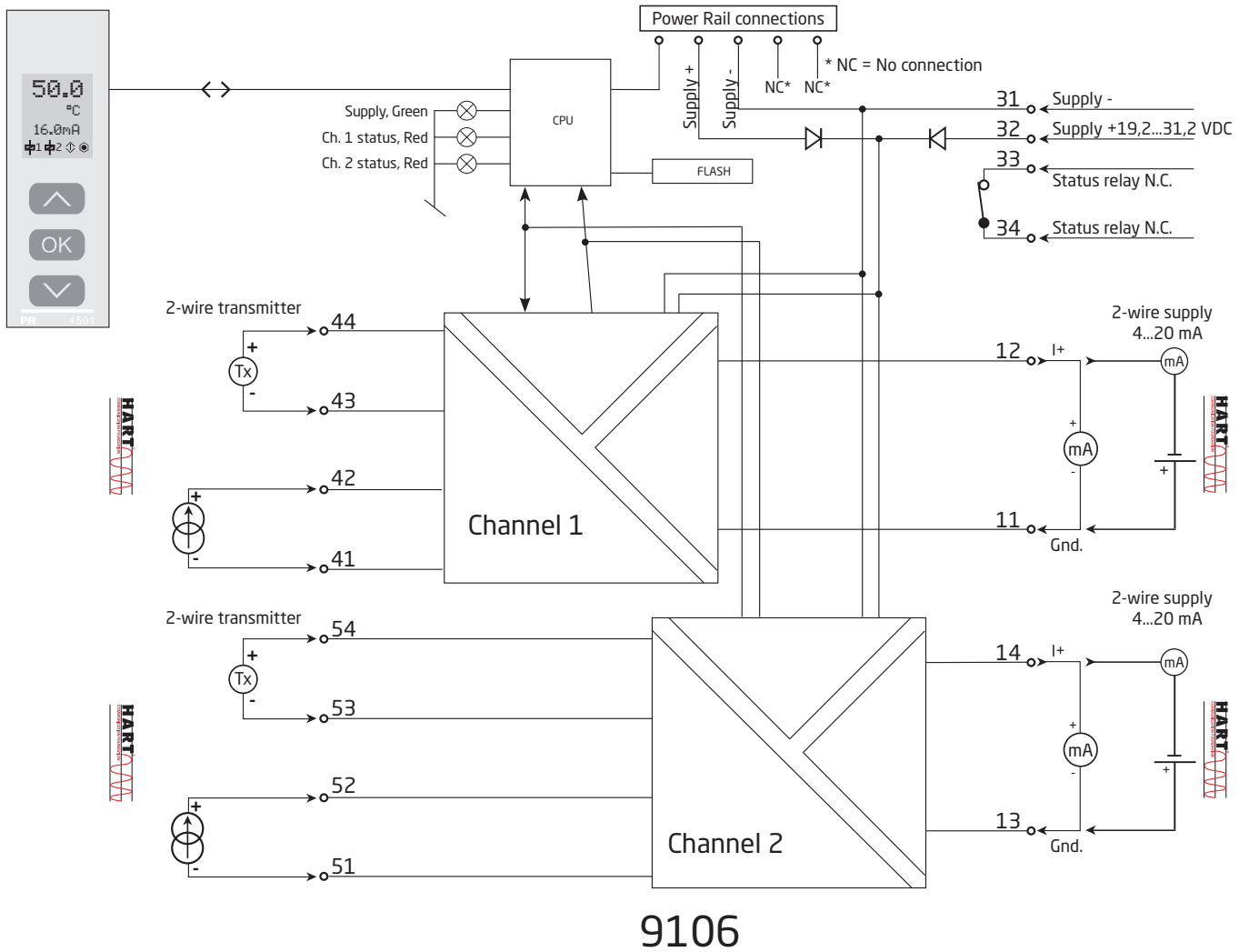

## Signal error indications without display front

List of LED and error signal indications					
Condition	Green LED	Ch. 1: Red	Ch. 2: Red	Status relay, N.C.	Power rail signal status
Device OK	Blinking	OFF	OFF	Energized	OFF
No supply	OFF	OFF	OFF	De-energized	ON
Device defective	Blinking	ON	ON	De-energized	ON
Ch. 1 defective (ch. 2 OK)	Blinking	ON	OFF	De-energized	ON
Ch. 2 defective (ch. 1 OK)	Blinking	OFF	ON	De-energized	ON
Channel 1, signal OK	Blinking	OFF	OFF	Energized	OFF
Ch. 1, signal limit exceeded	Blinking	Blinking	OFF	De-energized	ON (if activated)
Ch. 1, fixed loop break limit exceeded	Blinking	Flashing	OFF	De-energized	ON (if activated)
Channel 2, signal OK	Blinking	OFF	OFF	Energized	OFF
Ch. 2, signal limit exceeded	Blinking	OFF	Blinking	De-energized	ON (if activated)
Ch. 2, fixed loop break limit exceeded	Blinking	OFF	Flashing	De-energized	ON (if activated)

Blinking : 50% ON and 50% OFF 

Flashing : 8% ON and 92% OFF 



# Configuration / operating the function keys

Documentation for routing diagram.

## In general

When configuring the 9106, you will be guided through all parameters and you can choose the settings which fit the application. For each menu there is a scrolling help text which is automatically shown in line 3 on the display.

Configuration is carried out by use of the 3 function keys:

- ⏪ will increase the numerical value or choose the next parameter
- ⏩ will decrease the numerical value or choose the previous parameter
- ⏹ will save the chosen value and proceed to the next menu

When configuration is completed, the display will return to the default state 1.0. Pressing and holding ⏹ will return to the previous menu or return to the default state (1.0) without saving the changed values or parameters.

If no key is activated for 1 minute, the display will return to the default state (1.0) without saving the changed values or parameters.

## Further explanations

**Password protection:** Programming access can be blocked by assigning a password. The password is saved in the device in order to ensure a high degree of protection against unauthorized modifications to the configuration. If the configured password is not known, please contact PR electronics support - [www.prelectronics.com/contact](http://www.prelectronics.com/contact).

## Loop limits

In the menus LO.LIM and HI.LIM you can choose the current values which will trigger a loop error alarm from the status relay. The NAMUR NE43 limits are selected by setting LO.LIM at 3.6 mA and HI.LIM at 21 mA. The selected limits are identical for both channels. This function can be deactivated by selecting limits outside the range 3.5...23 mA. Alternatively, the status relay can be used as a simple limit switch in the 1-channel version.

The loop break limit is fixed  $\leq 1$  mA. If this limit is exceeded, the status relay will be de-energized.

## Signal and sensor error indication via display front 45xx

Sensor error (loop break) is shown in line 1 on the display by flashing  $\text{!}$  and  $\text{!}$ . The actual mA value is also shown followed by an explanatory text. Channel 1 is shown in line 2 and channel 2 is shown in line 3 on the display.

Line 4 on the display shows the condition of the COM (flashing bullet) indicating correct functioning of 45xx.

## Advanced functions

The unit gives access to a number of advanced functions which can be reached by answering "Yes" to the point "ADV.SET".

**Display setup:** Here you can adjust the brightness contrast and the backlight. Setup of tag numbers with 5 alphanumeric. Selection of functional readout in line 2 and 3 on the display - choose between readout of loop current or tag no. When selecting "ALT" the readout toggles between loop current and tag no.

**Password:** Here you can choose a password between 0000 and 9999 in order to protect the unit against unauthorised modifications to the configuration. The unit is delivered default without password.

**Language:** In the menu "LANG" you can choose between 7 different language versions of help texts that will appear in the menu. You can choose between UK, DE, FR, IT, ES, SE and DK.

**Power rail:** In the menu "RAIL" you can choose if a signal is transmitted to the central surveillance in the PR 9410 power control unit when the signal limits are exceeded.

**Safety Integrity Level (SIL):** See Safety Manual for details.



# Routing diagram

If no key is activated for 1 minute, the display will return to the default state 1.0 without saving configuration changes.

⏴ Increase value / choose next parameter

⏵ Decrease value / choose previous parameter

OK Save the chosen value and proceed to the next menu

Hold OK Back to previous menu / return to menu 1.0 without saving.

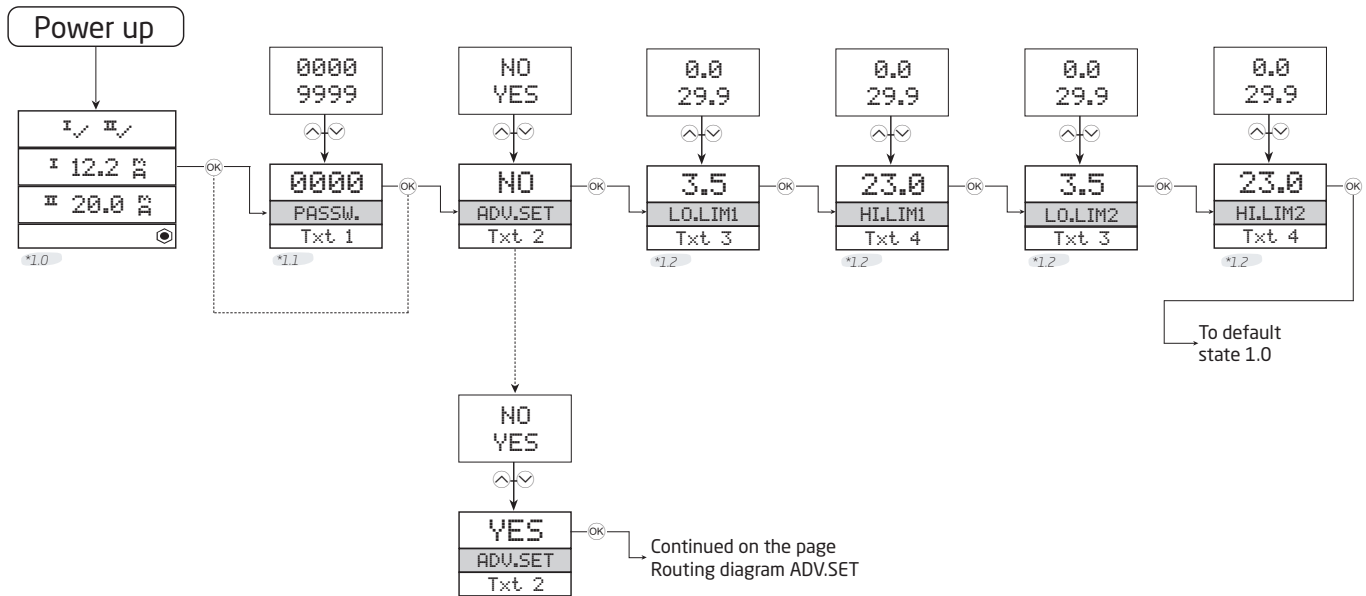

\*1.0 Default state.  
Line 1 shows status for channel 1 and channel 2  
Line 2 shows analogue value or tag no. for channel 1.  
If the loop limit is exceeded (LO.LIM and HI.LIM) the analog value is shown for 5 sec. followed by txt 18.  
In case of loop break, 0.0 is shown for 5 sec. followed by txt 19.  
Line 3 shows the same as line 2, only for channel 2.  
Line 4 shows status for communication.

\*1.1 Only if password-protected.

\*1.2 Loop current limits (identical for both channels) can be deactivated by selecting values outside the range 3.5...23 mA.

Line 1 symbols:  
I✓ = OK. Flashing II! = error.

# Routing diagram, advanced settings (ADV.SET)

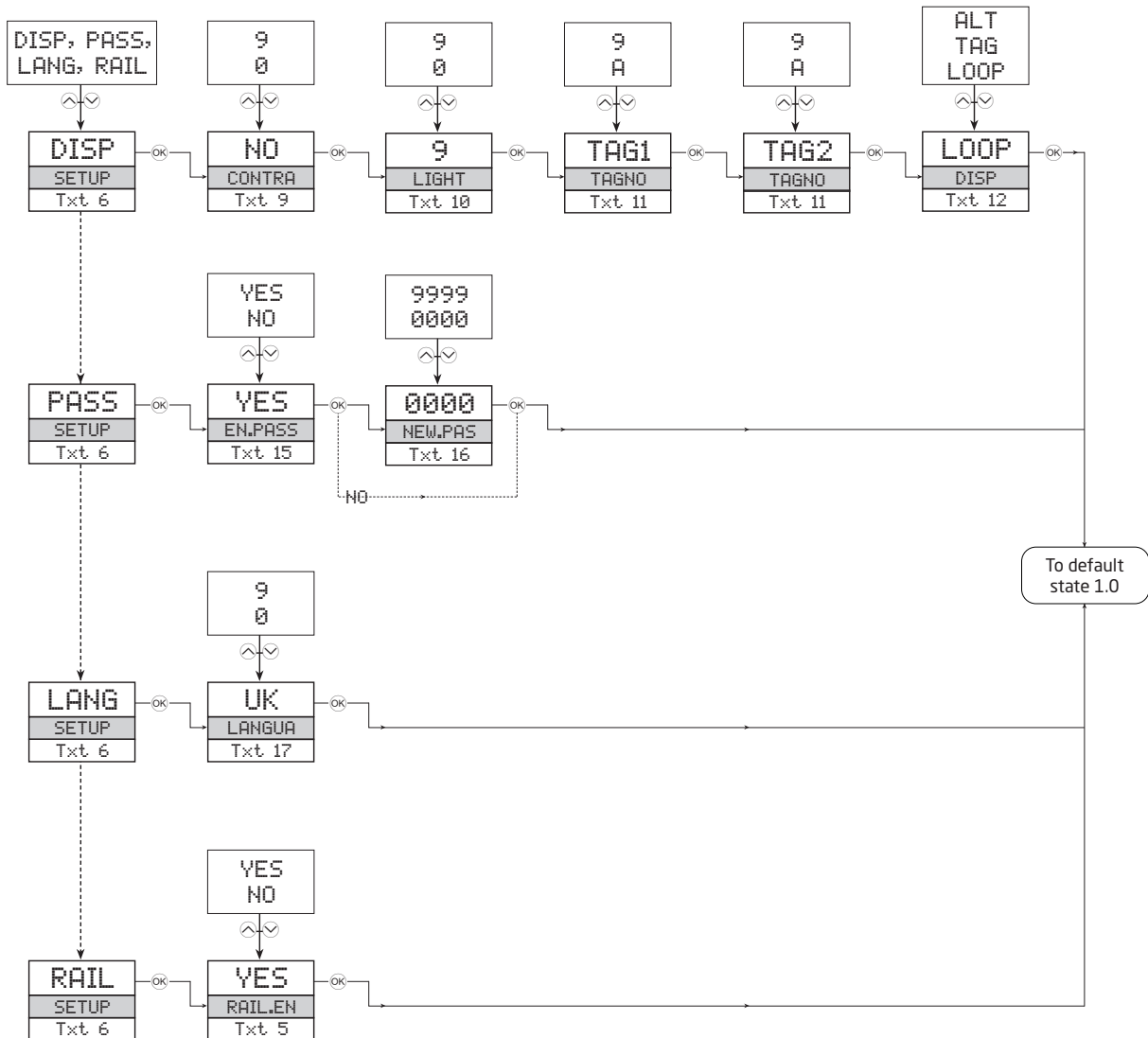

## Help text overview

- [01] Set correct password [PASS]
- [02] Enter advanced setup [ADV.SET]
- [03] Set low limit for loop error detection [LO.LIM1] [LO.LIM2]
- [04] Set high limit for loop error detection [HI.LIM1] [HI.LIM2]
- [05] Enable rail status signal output? [RAIL.ER]
- [06] Enter display setup [SETUP]
  - Enter password setup [SETUP]
  - Enter language setup [SETUP]
  - Enter rail setup [SETUP]
- [09] Adjust LCD contrast [CONTRA]
- [10] Adjust LCD backlight [LIGHT]
- [11] Write a 5-character tag no. [TAGNO1] [TAGNO2]
- [12] Show loop values in display
  - Show Tag no. in display
  - Alternate shown information in display
- [15] Enable password protection [EN.PASS]
- [16] Set new password [NEW.PAS]
- [17] Select language [LANGUA]
- [18] Loop signal limit exceeded
- [19] Loop wire breakage
- [20] No communication - check connections
- [21] Eeprom error - check configuration
- [22] Hardware error

LERBAKKEN 10, 8410 RØNDE DENMARK

## IECEX Installation drawing



For safe installation of 9106B the following must be observed. The module shall only be installed by qualified personnel who are familiar with the national and international laws, directives and standards that apply to this area.

Year of manufacture can be taken from the first two digits in the serial number.



For Installation in Zone 2 the following must be observed.

The 4501 programming module is to be used solely with PRelectronics modules. It is important that the module is undamaged and has not been altered or modified in any way. Only 4501 modules free of dust and moisture shall be installed.

9106B1A: 1 channel HART  -transparent repeater (27.5V Barrier)

9106B1B: 2 channel HART  -transparent repeater (27.5V Barrier)

9106B2A: 1 channel HART  -transparent repeater (25.3V Barrier)

9106B2B: 2 channel HART  -transparent repeater (25.3V Barrier)

**IECEX Certificate:** ..... IECEX DEK 11.0084X

**Marking 9106Bxx**

[Ex ia Ga] IIC/IIB/IIA

**[Ex ia Da] IIIC**

[Ex ia Ma] I

**Marking 9106Bxx, 9106Axx**

**Ex nA nC IIC T4 Gc and Ex ec dc IIC T4 Gc**

**Standards**

IEC60079-15 :2015, IEC60079-11:2011, IEC60079-0: 2011, IEC60079-7:2015

**Supply terminal (31,32)**

Voltage:

19.2 – 31.2VDC

**Status Relay. terminal (33,34)**

Voltage max:

125VAC / 110VDC

Zone 2 installation

32VAC / 32VDC

Power max:

62,5VA / 32W

16 VA / 32 W

Current max:

0.5A AC / 0.3ADC

0.5A AC / 1ADC

**Installation notes:**

Install in pollution degree 2, overvoltage category II as defined in IEC 60664-1

Do not separate connectors when energized and an explosive gas mixture is present.

Do not mount or remove modules from the Power Rail when an explosive gas mixture is present.

Disconnect power before servicing.

The wiring of unused terminals is not allowed.

The Loop Supply and Current Input terminals for the same channel shall not be applied at the same time.

In type of protection [Ex ia Da] the parameters for intrinsic safety for gas group IIB are applicable.

For installation in Zone 2, the module shall be installed in an enclosure in type of protection Ex n or Ex e, providing a degree of protection of at least IP54. Cable entry devices and blanking elements shall fulfill the same requirements.

For installation on Power Rail in Zone 2, only Power Rail type 9400 supplied by Power Control Unit type 9410 (Type Examination Certificate KEMA 07ATEX0152 X) is allowed.

Revision date:  
2020-01-20

Version Revision  
V6 R0

Prepared by:  
PB

Page:  
1/6

LERBAKKEN 10, 8410 RØNDE DENMARK

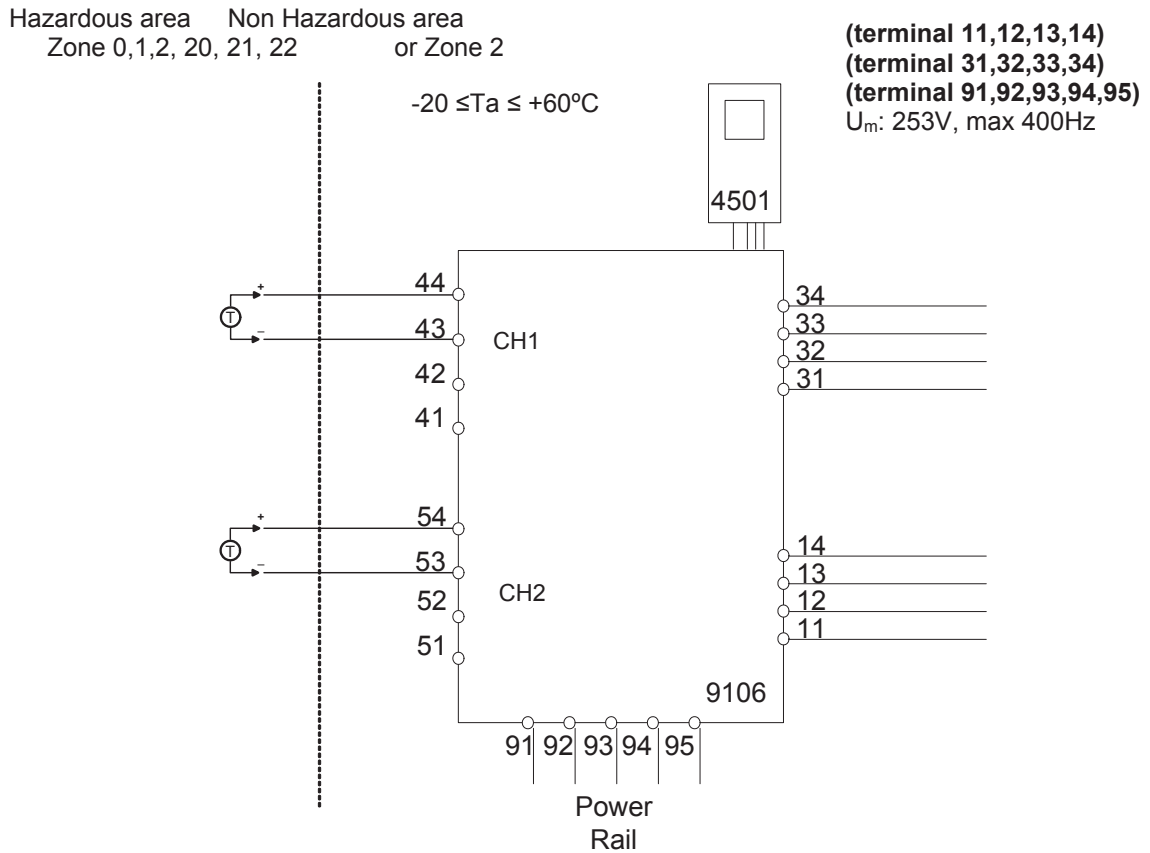

**9106B1A, 9106B1B**

**Ex input : Loop current source**  
**CH1 (terminal 43,44)**  
**CH2 (terminal 53,54)**  
 $U_o: 27.5\text{ V}$   
 $I_o: 92.6\text{ mA}$   
 $P_o: 0.64\text{ W}$

**9106B2A, 9106B2B**

**Ex input : Loop current source**  
**CH1 (terminal 43,44)**  
**CH2 (terminal 53,54)**  
 $U_o: 25.3\text{ V}$   
 $I_o: 96\text{ mA}$   
 $P_o: 0.61\text{ W}$

	IIC	IIB	IIA	I
$C_o$	0.084 $\mu\text{F}$	0.670 $\mu\text{F}$	2.23 $\mu\text{F}$	3.94 $\mu\text{F}$
$L_o$	4.15 mH	16.59 mH	33.17 mH	54.42 mH
$L_o/R_o$	-----	223 $\mu\text{H}/\Omega$	447 $\mu\text{H}/\Omega$	733 $\mu\text{H}/\Omega$

	IIC	IIB	IIA	I
$C_o$	0.104 $\mu\text{F}$	0.818 $\mu\text{F}$	2.85 $\mu\text{F}$	4.74 $\mu\text{F}$
$L_o$	3.86 mH	15.43 mH	30.86 mH	50.64 mH
$L_o/R_o$	-----	234 $\mu\text{H}/\Omega$	468 $\mu\text{H}/\Omega$	769 $\mu\text{H}/\Omega$

LERBAKKEN 10, 8410 RØNDE DENMARK

Hazardous area  
Zone 0,1,2, 20, 21, 22

Non Hazardous area  
or Zone 2

$-20 \leq T_a \leq +60^\circ\text{C}$

(terminal 11,12,13,14)  
(terminal 31,32,33,34)  
(terminal 91,92,93,94,95)  
 $U_m: 253\text{V, max } 400\text{Hz}$

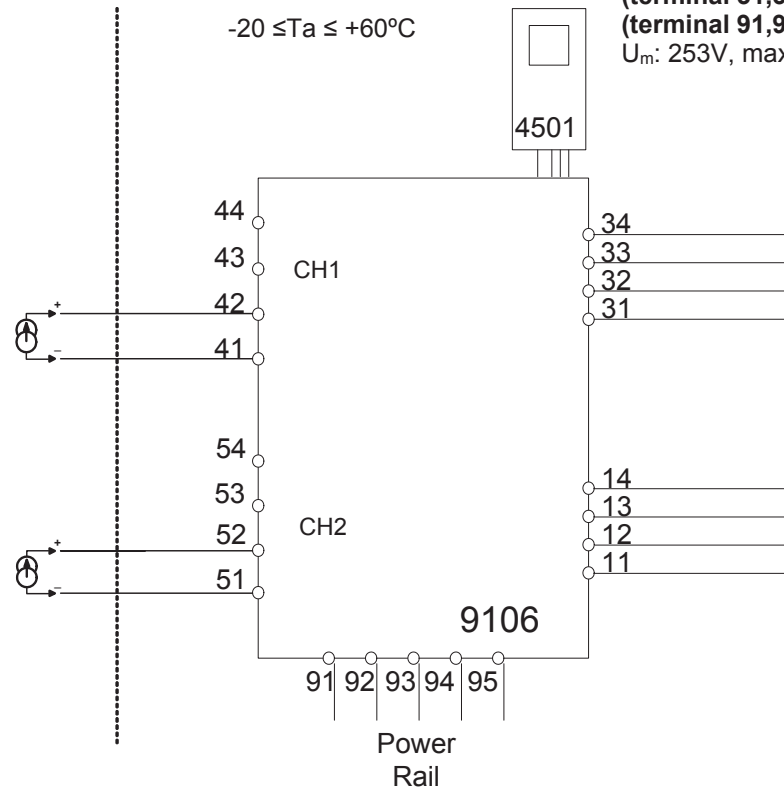

**9106B1A, 9106B1B, 9106B2A, 9106B2B**

**Ex input : External current source**

**CH1 (terminal 41,42)**

**CH2 (terminal 51,52)**

$U_o:$  0 V  
 $I_o:$  0 mA  
 $P_o:$  0 mW

$U_i:$  30 V  
 $I_i:$  120 mA  
 $P_i:$  0.85 W  
 $C_i:$  2 nF  
 $L_i:$  0  $\mu\text{H}$

LERBAKKEN 10, 8410 RØNDE DENMARK

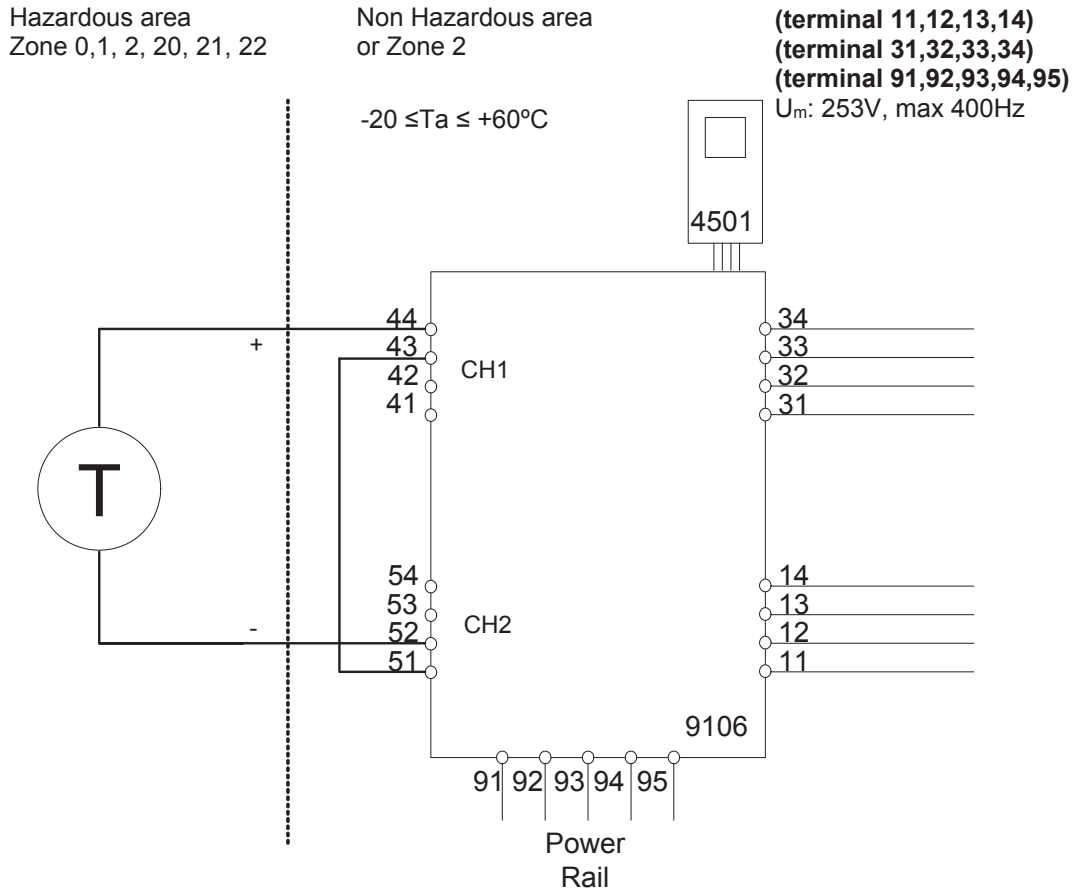

**9106B1A, 9106B1B**

**Ex input: Loop current source 1 to 2**

**CH1 (terminal 44)**

**CH2 (terminal 52)**

$U_o:$  27.5 V  
 $I_o:$  92.6 mA  
 $P_o:$  0.64 W

**9106B2A, 9106B2B**

**Ex input: Loop current source 1 to 2**

**CH1 (terminal 44)**

**CH2 (terminal 52)**

$U_o:$  25,3 V  
 $I_o:$  96 mA  
 $P_o:$  0.61 W

	IIC	IIB	IIA	I
$C_o$	0.084 $\mu\text{F}$	0.670 $\mu\text{F}$	2.23 $\mu\text{F}$	3.94 $\mu\text{F}$
$L_o$	4.15 mH	16.59 mH	33.17 mH	54.42 mH
$L_o/R_o$	-----	223 $\mu\text{H}/\Omega$	447 $\mu\text{H}/\Omega$	733 $\mu\text{H}/\Omega$

	IIC	IIB	IIA	I
$C_o$	0.104 $\mu\text{F}$	0.818 $\mu\text{F}$	2.85 $\mu\text{F}$	4.74 $\mu\text{F}$
$L_o$	3.86 mH	15.43 mH	30.86 mH	50.64 mH
$L_o/R_o$	-----	234 $\mu\text{H}/\Omega$	468 $\mu\text{H}/\Omega$	769 $\mu\text{H}/\Omega$



LERBAKKEN 10, 8410 RØNDE DENMARK

Hazardous area  
Zone 0,1,2, 20, 21, 22

Non Hazardous area  
or Zone 2

$-20 \leq T_a \leq +60^\circ\text{C}$

(terminal 11,12,13,14)  
(terminal 31,32,33,34)  
(terminal 91,92,93,94,95)  
 $U_m: 253\text{V, max } 400\text{Hz}$

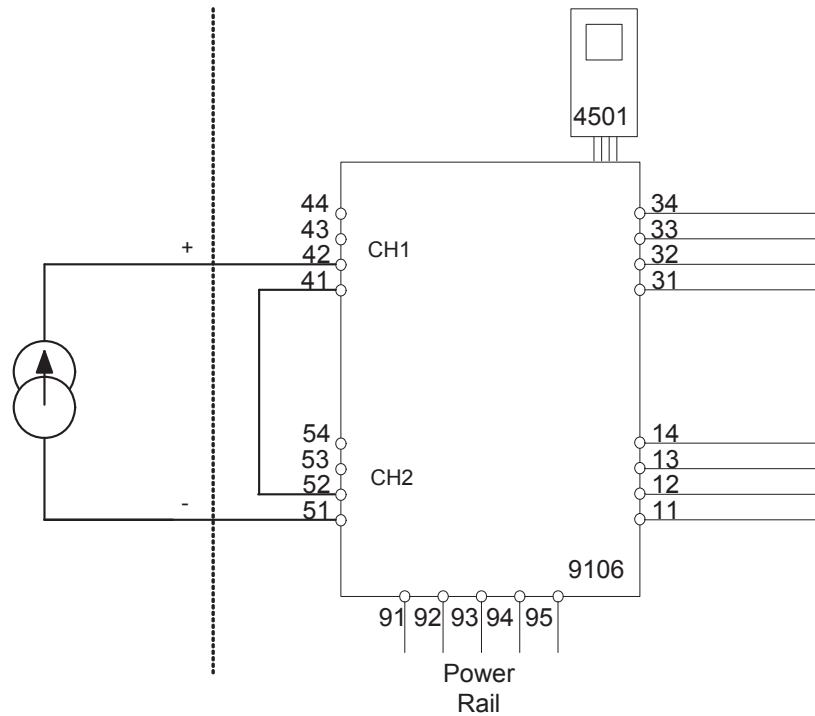

**9106B1A, 9106B1B, 9106B2A, 9106B2B**

**Ex input : External current source 1 to 2**

**CH1 (terminal 42)**

**CH2 (terminal 51)**

$U_o:$  0 V  
 $I_o:$  0 mA  
 $P_o:$  0 W

$U_i:$  30 V  
 $I_i:$  120 mA  
 $P_i:$  0.85 W  
 $C_i:$  4 nF  
 $L_i:$  0  $\mu\text{H}$

LERBAKKEN 10, 8410 RØNDE DENMARK

## ATEX Installation drawing



For safe installation of 9106B the following must be observed. The module shall only be installed by qualified personnel who are familiar with the national and international laws, directives and standards that apply to this area.

Year of manufacture can be taken from the first two digits in the serial number.

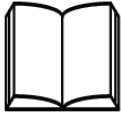

For Installation in Zone 2 the following must be observed.

The 4501 programming module is to be used solely with PRelectronics modules. It is important that the module is undamaged and has not been altered or modified in any way. Only 4501 modules free of dust and moisture shall be installed.

9106B1A: 1 channel HART □ -transparent repeater (27.5V Barrier)

9106B1B: 2 channel HART □ -transparent repeater (27.5V Barrier)

9106B2A: 1 channel HART □ -transparent repeater (25.3V Barrier)

9106B2B: 2 channel HART □ -transparent repeater (25.3V Barrier)

### ATEX Certificate

DEKRA 11ATEX0244X

### Marking

II (1) G [Ex ia Ga] IIC/IIB/IIA

II 3 G Ex nA nC IIC T4 Gc

II (1) D [Ex ia Da] IIIC

I (M1) [Ex ia Ma] I

### Standards

EN 60079-0: 2012+A11, EN 60079-11 : 2012,  
EN 60079-15:2010

### Supply terminal (31,32)

Voltage: 19.2 – 31.2VDC

### Status Relay terminal (33,34)

Voltage max: 125VAC / 110VDC

Power max: 62,5VA / 32W

Current max: 0.5A AC / 0.3ADC

### Zone 2 installation

32VAC / 32VDC

16 VA / 32 W

0.5A AC / 1ADC

### Installation notes:

Install in pollution degree 2, overvoltage category II as defined in EN60664-1

Do not separate connectors when energized and an explosive gas mixture is present.

Do not mount or remove modules from the Power Rail when an explosive gas mixture is present.

Disconnect power before servicing.

The wiring of unused terminals is not allowed.

The Loop Supply and Current Input terminals for the same channel shall not be applied at the same time.

In type of protection [Ex ia Da] the parameters for intrinsic safety for gas group IIB are applicable.

For installation in Zone 2, the module shall be installed in an enclosure in type of protection Ex n or Ex e, providing a degree of protection of at least IP54. Cable entry devices and blanking elements shall fulfill the same requirements.

For installation on Power Rail in Zone 2, only Power Rail type 9400 supplied by Power Control Unit type 9410 (Type Examination Certificate KEMA 07ATEX0152 X) is allowed.

LERBAKKEN 10, 8410 RØNDE DENMARK

Hazardous area  
Zone 0,1,2, 20, 21, 22

Non Hazardous area  
or Zone 2

$$-20 \leq T_a \leq +60^{\circ}\text{C}$$

(terminal 11,12,13,14)  
(terminal 31,32,33,34)  
(terminal 91,92,93,94,95)  
 $U_m: 253\text{V, max } 400\text{Hz}$

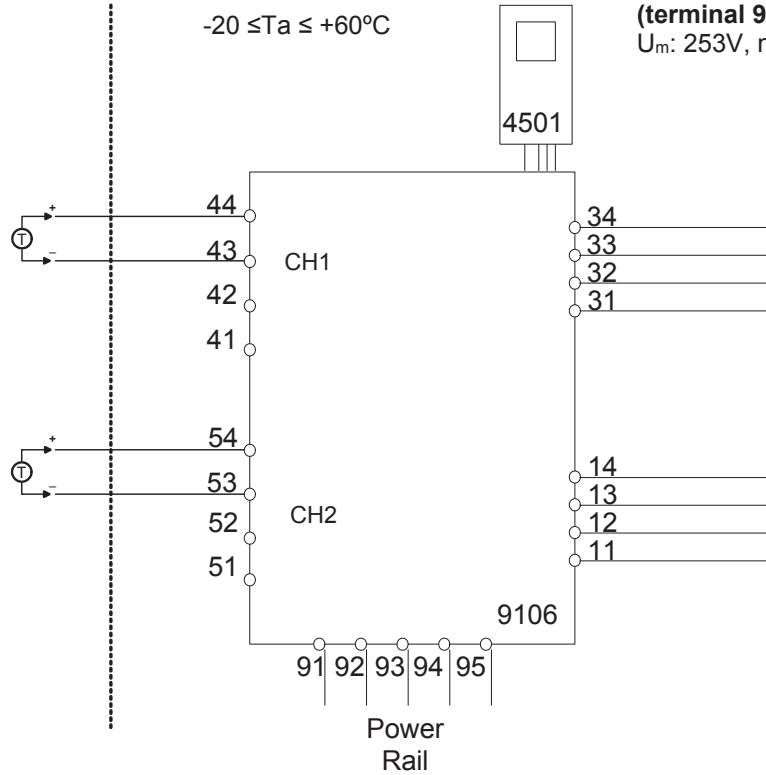

**9106B1A, 9106B1B**

**Ex input : Loop current source**

**CH1 (terminal 43,44)**

**CH2 (terminal 53,54)**

$U_o:$  27.5 V  
 $I_o:$  92.6 mA  
 $P_o:$  0.64 W

	IIC	IIB	IIA	I
$C_o$	0.084 $\mu\text{F}$	0.670 $\mu\text{F}$	2.23 $\mu\text{F}$	3.94 $\mu\text{F}$
$L_o$	4.15 mH	16.59 mH	33.17 mH	54.42 mH
$L_o/R_o$	-----	223 $\mu\text{H}/\Omega$	447 $\mu\text{H}/\Omega$	733 $\mu\text{H}/\Omega$

**9106B2A, 9106B2B**

**Ex input : Loop current source**

**CH1 (terminal 43,44)**

**CH2 (terminal 53,54)**

$U_o:$  25.3 V  
 $I_o:$  96 mA  
 $P_o:$  0.61 W

	IIC	IIB	IIA	I
$C_o$	0.104 $\mu\text{F}$	0.818 $\mu\text{F}$	2.85 $\mu\text{F}$	4.74 $\mu\text{F}$
$L_o$	3.86 mH	15.43 mH	30.86 mH	50.64 mH
$L_o/R_o$	-----	234 $\mu\text{H}/\Omega$	468 $\mu\text{H}/\Omega$	769 $\mu\text{H}/\Omega$

LERBAKKEN 10, 8410 RØNDE DENMARK

Hazardous area  
Zone 0,1,2, 20, 21, 22

Non Hazardous area  
or Zone 2

$-20 \leq T_a \leq +60^\circ\text{C}$

(terminal 11,12,13,14)  
(terminal 31,32,33,34)  
(terminal 91,92,93,94,95)  
 $U_m: 253\text{V, max } 400\text{Hz}$

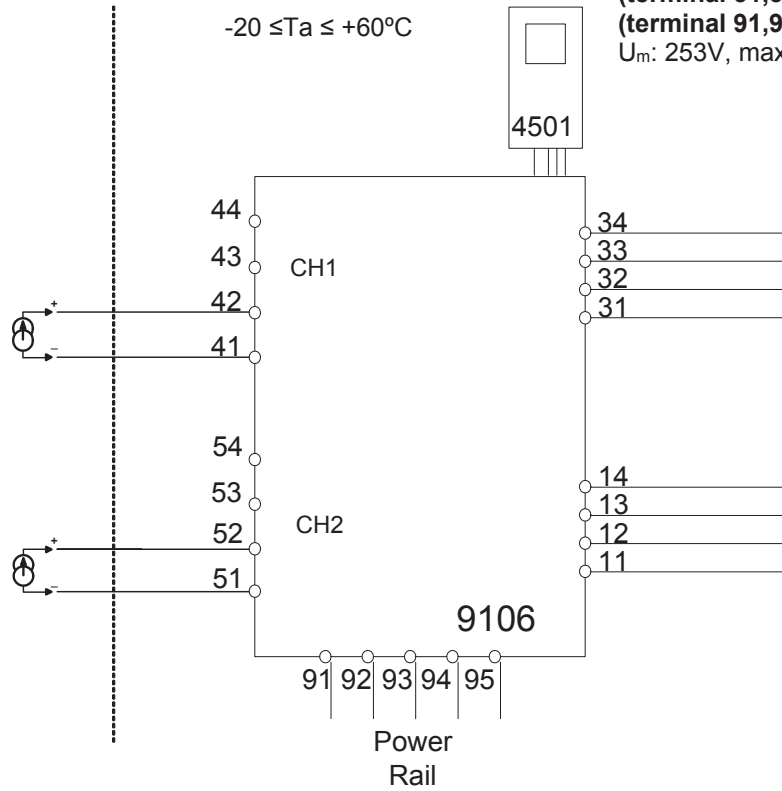

**9106B1A, 9106B1B, 9106B2A, 9106B2B**

**Ex input : External current source**

**CH1 (terminal 41,42)**

**CH2 (terminal 51,52)**

$U_o:$  0 V  
 $I_o:$  0 mA  
 $P_o:$  0 mW

$U_i:$  30 V  
 $I_i:$  120 mA  
 $P_i:$  0.85 mW  
 $C_i:$  2 nF  
 $L_i:$  0  $\mu\text{H}$

LERBAKKEN 10, 8410 RØNDE DENMARK

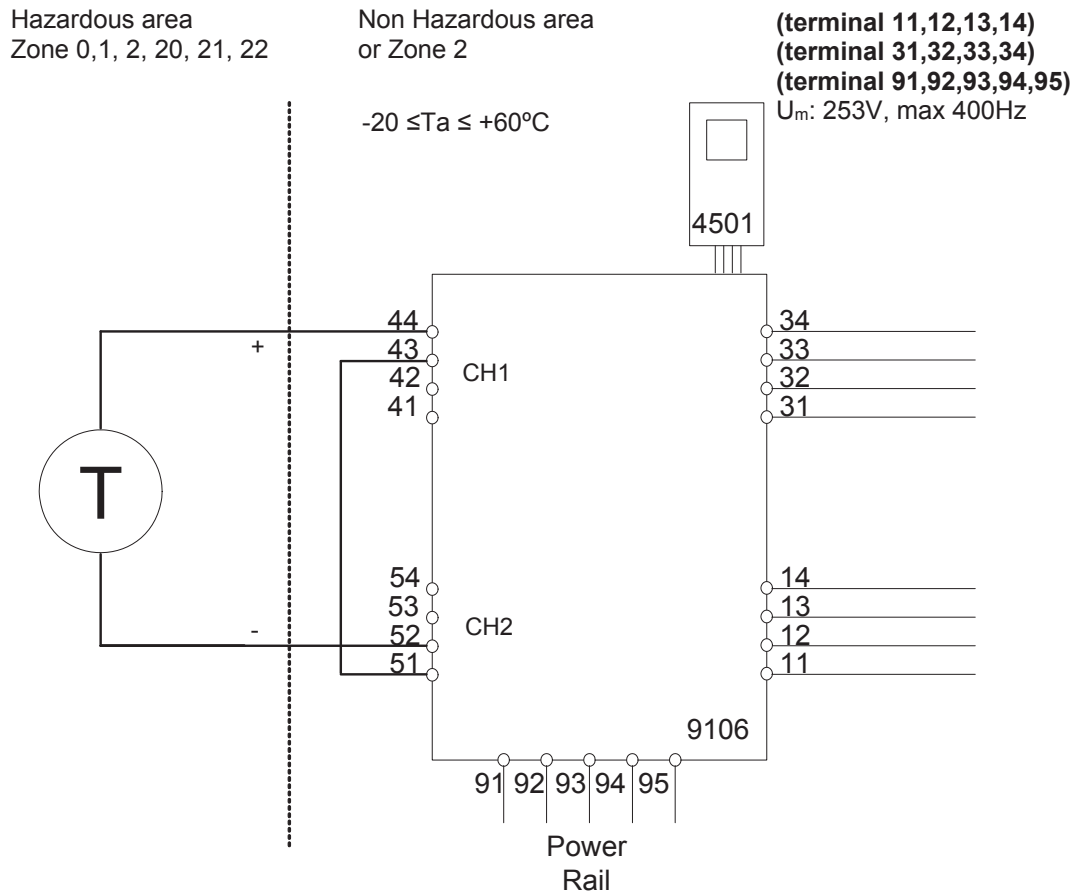

**9106B1A, 9106B1B**

**Ex input: Loop current source 1 to 2**

**CH1 (terminal 44)**

**CH2 (terminal 52)**

U<sub>o</sub>: 27.5 V  
I<sub>o</sub>: 92.6 mA  
P<sub>o</sub>: 0.64 W

**9106B2A, 9106B2B**

**Ex input: Loop current source 1 to 2**

**CH1 (terminal 44)**

**CH2 (terminal 52)**

U<sub>o</sub>: 25.3 V  
I<sub>o</sub>: 96 mA  
P<sub>o</sub>: 0.61 W

	IIC	IIB	IIA	I
C <sub>o</sub>	0.084μF	0.670μF	2.23 μF	3.94 μF
L <sub>o</sub>	4.15 mH	16.59 mH	33.17 mH	54.42 mH
L <sub>o</sub> /R <sub>o</sub>	-----	223 μH/Ω	447 μH/Ω	733 μH/Ω

	IIC	IIB	IIA	I
C <sub>o</sub>	0.104μF	0.818μF	2.85 μF	4.74 μF
L <sub>o</sub>	3.86 mH	15.43 mH	30.86 mH	50.64 mH
L <sub>o</sub> /R <sub>o</sub>	-----	234 μH/Ω	468 μH/Ω	769 μH/Ω

LERBAKKEN 10, 8410 RØNDE DENMARK

Hazardous area  
Zone 0,1,2, 20, 21, 22

Non Hazardous area  
or Zone 2

$-20 \leq T_a \leq +60^\circ\text{C}$

(terminal 11,12,13,14)  
(terminal 31,32,33,34)  
(terminal 91,92,93,94,95)  
 $U_m: 253\text{V, max } 400\text{Hz}$

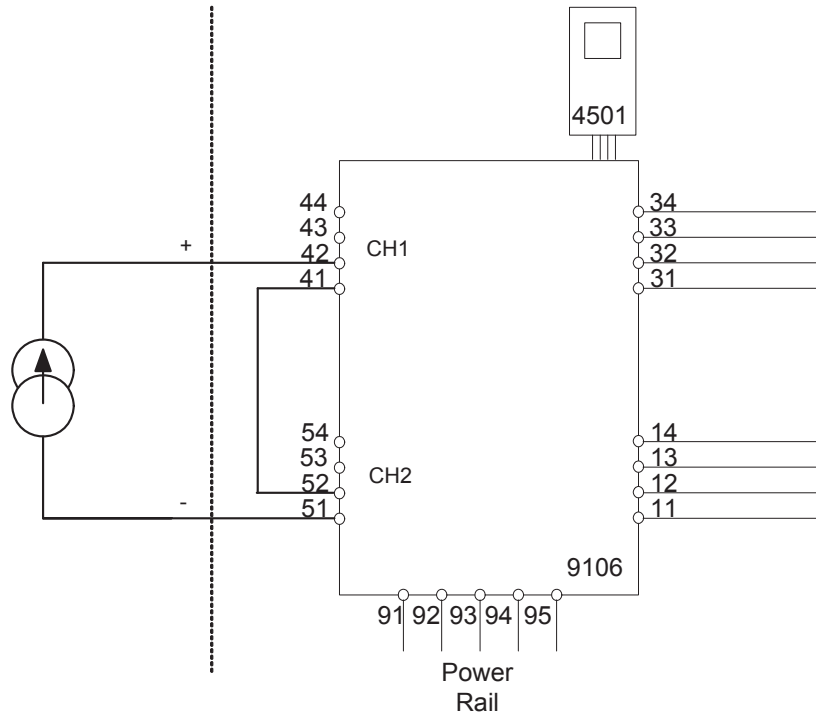

**9106B1A, 9106B1B, 9106B2A, 9106B2B**

**Ex input : External current source 1 to 2**

**CH1 (terminal 42)**

**CH2 (terminal 51)**

$U_o:$  0 V  
 $I_o:$  0 mA  
 $P_o:$  0 W

$U_i:$  30 V  
 $I_i:$  120 mA  
 $P_i:$  0.85 W  
 $C_i:$  4 nF  
 $L_i:$  0  $\mu\text{H}$

## FM Installation drawing



For safe installation of 9106B the following must be observed. The module shall only be installed by qualified personnel who are familiar with the national and international laws, directives and standards that apply to this area.

Year of manufacture can be taken from the first two digits in the serial number.

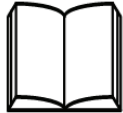

For Installation in Div2/Zone2 the following must be observed.

The 4501 programming module is to be used solely with PRElectronics modules. It is important that the module is undamaged and has not been altered or modified in any way. Only 4501 modules free of dust and moisture shall be installed.

### 9106Bab. HART Transparent Repeater

**a: Barrier (1 = 27.5V barrier; 2 = 25.3V barrier)**

**b: Channels (A = Single; B = Double)**

#### Supply terminal (31,32)

Voltage: 19.2 – 31.2VDC

#### Status Relay terminal (33,34)

Voltage max: 125VAC / 110VDC

Power max: 62,5VA / 32W

Current max: 0.5A AC / 0.3ADC

#### Zone 2 installation

32VAC / 32VDC

16 VA / 32 W

0.5A AC / 1ADC

#### Installation notes:

In Class I, Division 2 installations, the subject equipment shall be mounted within a too-secured enclosure which is capable of accepting one or more of the Class I, Division 2 wiring methods specified in the National Electrical Code (ANSI/NFPA 70), or Canadian Electrical Code (C22.1).

In Class I, Zone 2 installations, the subject equipment shall be mounted within a tool secured enclosure which is capable of accepting one or more of the Class I, Zone 2 wiring methods specified in the National Electrical Code (ANSI/NFPA 70) or Canadian Electrical Code (C22.1). Where installed in outdoor or potentially wet locations, the enclosure shall, at a minimum, meet the requirements of IP54.

Install in environments rated Pollution Degree 2 or better; overvoltage category I or II.

The equipment shall be installed in an enclosure with a minimum ingress protection rating of IP54 unless the apparatus is intended to be afforded an equivalent degree of protection by location.

The module is galvanically isolated and does not require grounding.

Use 60 / 75 °C copper conductors with wire size AWG: (26-14)

**Warning:** Substitution of components may impair intrinsic safety.

**Warning:** To prevent ignition of the explosive atmospheres, disconnect power before servicing and do not separate connectors, install or remove module from Power Rail when energized and an explosive gas mixture is present.

**Warning:** The Loop Supply and Current Input terminals for the same channel shall not be applied at the same time. The wiring of unused terminals is not allowed.

LERBAKKEN 10, 8410 RØNDE DENMARK

**Hazardous Classified Location**

Class I/II/III, Division 1, Group A,B,C,D,E,F,G  
or Class I, Zone 0/1 Group IIC, [AEx ia] IIC  
or Group IIC, [Ex ia Ga] IIC Gc

**Unclassified Location or  
Hazardous Classified Location**

Class I, Division 2, Group A,B,C,D T4  
or Class I Zone 2 Group IIC T4 Gc

Simple Apparatus or  
Intrinsic safe apparatus  
with entity parameters:

$V_{max}(U_i) \geq V_t(U_o)$   
 $I_{max}(I_i) \geq I_t(I_o)$   
 $P_i \geq P_t(P_o)$   
 $C_a \geq C_{cable} + C_i$   
 $L_a \geq L_{cable} + L_i$

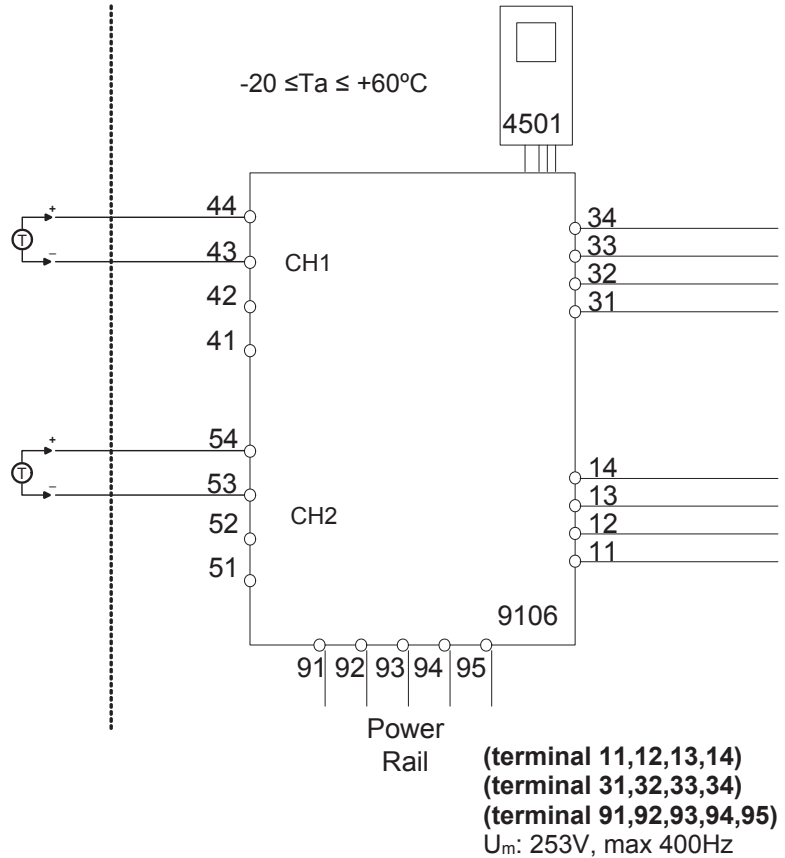

**9106B1A, 9106B1B**

**Ex input : Loop current source**

**CH1 (terminal 43,44)**

**CH2 (terminal 53,54)**

$U_o:$  27.5 V  
 $I_o:$  92.6 mA  
 $P_o:$  0.64 W

	IIC or A,B	IIB or C,E,F	IIA or D,G
$C_o$	0.084μF	0.670μF	2.24 μF
$L_o$	4.14 mH	16.58 mH	33.17 mH
$L_o/R_o$	-----	223 μH/Ω	447 μH/Ω

**9106B2A, 9106B2B**

**Ex input : Loop current source**

**CH1 (terminal 43,44)**

**CH2 (terminal 53,54)**

$U_o:$  25.3 V  
 $I_o:$  96 mA  
 $P_o:$  0.61 W

	IIC or A,B	IIB or C,E,F	IIA or D,G
$C_o$	0.104μF	0.818μF	2.85 μF
$L_o$	3.85 mH	15.43 mH	30.86 mH
$L_o/R_o$	-----	234 μH/Ω	468 μH/Ω



LERBAKKEN 10, 8410 RØNDE DENMARK

**Hazardous Classified Location**

Class I/II/III, Division 1, Group A,B,C,D,E,F,G  
or Class I, Zone 0/1 Group IIC, [AEx ia] IIC  
or Group IIC, [Ex ia Ga] IIC Gc

**Unclassified Location or  
Hazardous Classified Location**

Class I, Division 2, Group A,B,C,D T4  
or Class I Zone 2 Group IIC T4 Gc

Simple Apparatus or  
Intrinsic safe apparatus  
with entity parameters:

$V_{max} (U_i) \geq V_t (U_o)$   
 $I_{max} (I_i) \geq I_t (I_o)$   
 $P_i \geq P_t (P_o)$   
 $C_a \geq C_{cable} + C_i$   
 $L_a \geq L_{cable} + L_i$

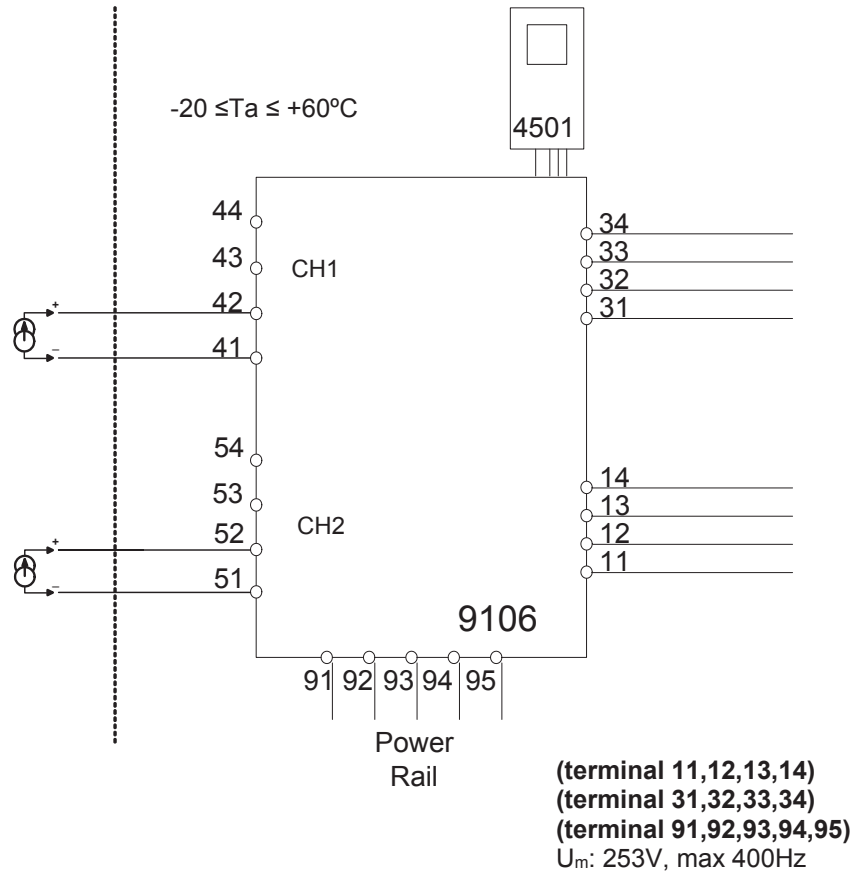

**9106B1A, 9106B1B, 9106B2A, 9106B2B**

**Ex input : External current source**

**CH1 (terminal 41,42)**

**CH2 (terminal 51,52)**

$U_o:$  0 V  
 $I_o:$  0 mA  
 $P_o:$  0 mW

$U_i:$  30 V  
 $I_i:$  120 mA  
 $P_i:$  0.85 W  
 $C_i:$  2 nF  
 $L_i:$  0 μH

LERBAKKEN 10, 8410 RØNDE DENMARK

**Hazardous Classified Location**

Class I/II/III, Division 1, Group A,B,C,D,E,F,G  
or Class I, Zone 0/1 Group IIC, [AEx ia] IIC  
or Group IIC, [Ex ia Ga] IIC Gc

**Unclassified Location or  
Hazardous Classified Location**

Class I, Division 2, Group A,B,C,D T4  
or Class I Zone 2 Group IIC T4 Gc

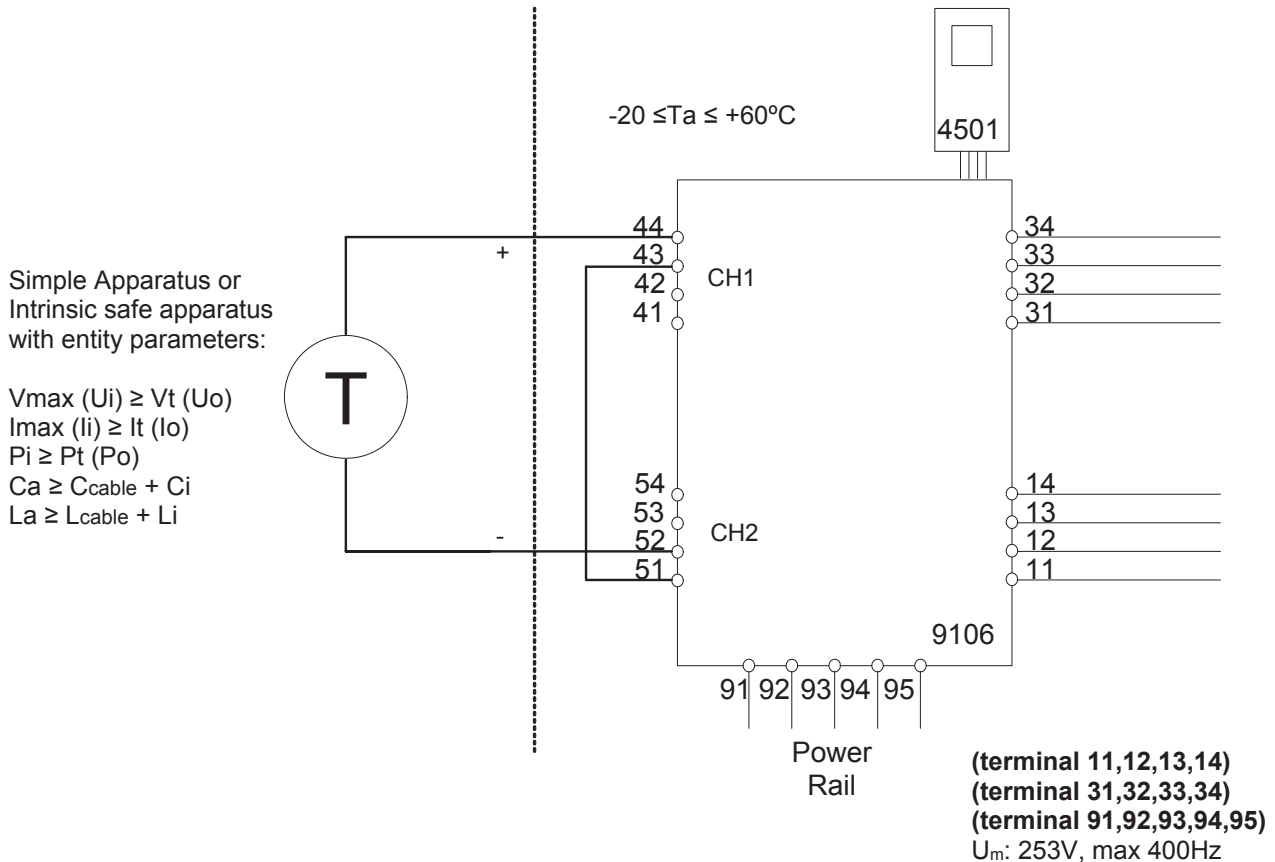

**9106B1A, 9106B1B**

**Ex input: Loop current source 1 to 2**  
**CH1 (terminal 44)**  
**CH2 (terminal 52)**

$U_o$ : 27.5 V  
 $I_o$ : 92.6 mA  
 $P_o$ : 0.64 W

	IIC or A,B	IIB or C,E,F	IIA or D,G
$C_o$	0.084μF	0.670μF	2.23 μF
$L_o$	4.14 mH	16.58 mH	33.17 mH
$L_o/R_o$	-----	223 μH/Ω	447 μH/Ω

**9106B2A, 9106B2B**

**Ex input: Loop current source 1 to 2**  
**CH1 (terminal 44)**  
**CH2 (terminal 52)**

$U_o$ : 25,3 V  
 $I_o$ : 96 mA  
 $P_o$ : 0.61 W

	IIC or A,B	IIB or C,E,F	IIA or D,G
$C_o$	0.104μF	0.818μF	2.85 μF
$L_o$	3.85 mH	15.43 mH	30.86 mH
$L_o/R_o$	-----	234 μH/Ω	468 μH/Ω

LERBAKKEN 10, 8410 RØNDE DENMARK

**Hazardous Classified Location**

Class I/II/III, Division 1, Group A,B,C,D,E,F,G  
or Class I, Zone 0/1 Group IIC, [AEx ia] IIC  
or Group IIC, [Ex ia Ga] IIC Gc

**Unclassified Location or  
Hazardous Classified Location**

Class I, Division 2, Group A,B,C,D T4  
or Class I Zone 2 Group IIC T4 Gc

Simple Apparatus or  
Intrinsic safe apparatus  
with entity parameters:

$V_{max}(U_i) \geq V_t(U_o)$   
 $I_{max}(I_i) \geq I_t(I_o)$   
 $P_i \geq P_t(P_o)$   
 $C_a \geq C_{cable} + C_i$   
 $L_a \geq L_{cable} + L_i$

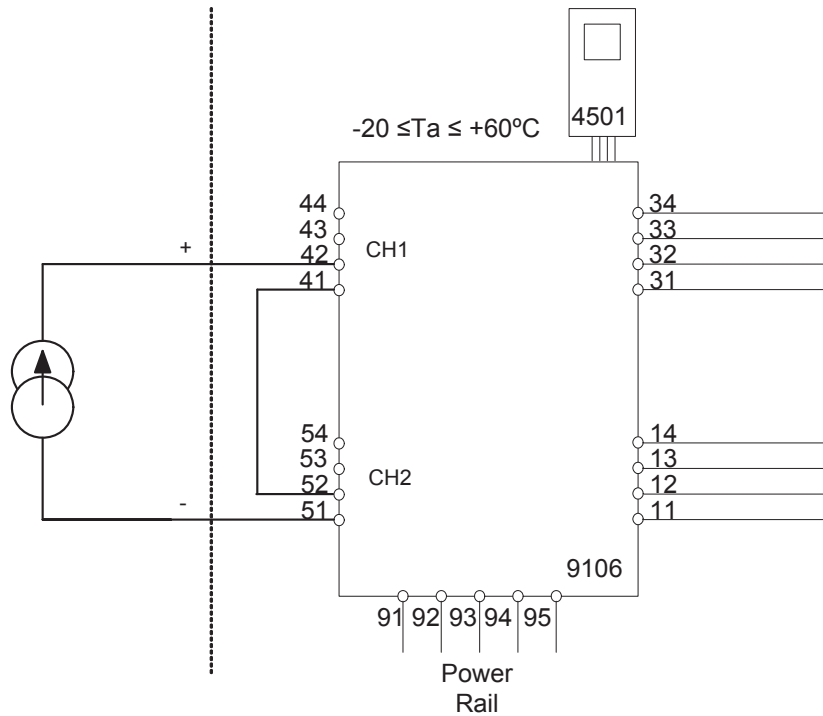

**9106B1A, 9106B1B, 9106B2A, 9106B2B**  
**Ex input : External current source 1 to 2**  
**CH1 (terminal 42)**  
**CH2 (terminal 51)**

$U_o:$  0 V  
 $I_o:$  0 mA  
 $P_o:$  0 W

$U_i:$  30 V  
 $I_i:$  120 mA  
 $P_i:$  0.85 W  
 $C_i:$  4 nF  
 $L_i:$  0 μH

**(terminal 11,12,13,14)**  
**(terminal 31,32,33,34)**  
**(terminal 91,92,93,94,95)**  
 $U_m:$  253V, max 400Hz

## UL Installation drawing



For safe installation of the **Process Control Equipment (Associated Apparatus) 9106** the following must be observed. The module shall only be installed by qualified personnel who are familiar with the national and international laws, directives and standards that apply to this area.



For Installation in Div2/Zone2 the following must be observed.  
The 4501 programming module is to be used solely with PR electronics modules. It is important that the module is undamaged and has not been altered or modified in any way. Only 4501 modules free of dust and moisture shall be installed.

9106A1A-U9 and 9106B1A-U9 :1 channel HART  -transparent repeater (27.5V Barrier)  
 9106A1B-U9 and 9106B1B-U9 :2 channel HART  -transparent repeater (27.5V Barrier)  
 9106A2A-U9 and 9106B2A-U9 :1 channel HART  -transparent repeater (25.3V Barrier)  
 9106A2B-U9 and 9106B2B-U9 :2 channel HART  -transparent repeater (25.3V Barrier)

### Marking:



Proc. Cont. Eq. for Use in Haz. Loc.  
 Install in CL I DIV2 GP A-D T4 provide  
 IS circuits to CL I-III DIV 1 GP A-G  
 or CL I Zn2 Gp IIC T4 provides IS  
 E233311 circuits for CL I Zn0 Gp IIC/Zn20 Gp IIIC  
 Um=253V [Exia] Installation Drawing: 9106QU01

The 9106Bxx is a galvanically isolating associated apparatus intended for installation in non-hazardous locations or Class I, Division 2, Groups A – D hazardous locations with intrinsically safe connections to Class I, II and III hazardous locations.



Proc. Cont. Eq. for Use in Haz. Loc.  
 Install in CL I DIV2 GP A-D T4  
 or CL I Zn2 Gp IIC T4  
 E233311 Installation Drawing: 9106QU01

The 9106Axx equipment is intended for installation in non-hazardous locations or Class I, Division 2, Groups A – D or Zone 2 Group IIC hazardous locations.

### Standards:

- UL 121201 NONINCENDIVE ELECTRICAL EQUIPMENT FOR USE IN CLASS I AND II, DIVISION 2 AND CLASS III, DIVISIONS 1 AND 2 HAZARDOUS (CLASSIFIED) LOCATIONS Edition 9 - Revision Date 2018/08/31
- CSA C22.2 NO. 213 NONINCENDIVE ELECTRICAL EQUIPMENT FOR USE IN CLASS I AND II, DIVISION 2 AND CLASS III, DIVISIONS 1 AND 2 HAZARDOUS (CLASSIFIED) LOCATIONS- Edition 3 - Issue Date 2017/09/01
- UL 913 STANDARD FOR INTRINSICALLY SAFE APPARATUS AND ASSOCIATED APPARATUS FOR USE IN CLASS I, II, III, DIVISION 1, HAZARDOUS (CLASSIFIED) LOCATIONS- Edition 8 - Revision Date 2015/10/16
- CSA C22.2 NO. 60079-0 EXPLOSIVE ATMOSPHERES — PART 0: EQUIPMENT — GENERAL REQUIREMENTS- Edition 3 - Issue Date 2015/10/01
- CSA C22.2 NO. 60079-11:14 EXPLOSIVE ATMOSPHERES — PART 11: EQUIPMENT PROTECTION BY INTRINSIC SAFETY "I"- Edition 2 - Issue Date 2014/02/01

LERBAKKEN 10, 8410 RØNDE DENMARK

**Installation notes 9106Axx and 9106Bxx:**

The module must be installed in an tool-secured enclosure suitable for the application in accordance with the National Electrical Code (ANSI/NFPA 70) for installation in the United States, the Canadian Electrical Code for installations in Canada, or other local codes, as applicable.

The module is galvanically isolated and does not require grounding.

Terminal 41, 42, 43, 44 are internally connected to CH1.  
Terminal 51, 52, 53, 54 are internally connected to CH2.

Install in pollution degree 2, overvoltage category II in accordance with IEC 60664-1.

Use minimum 75 °C copper conductors with wire size AWG: (26-14)

**Warning:** Substitution of components may impair intrinsic safety.

**Avertissement :** La substitution des composants peut nuire à la sécurité intrinsèque.

There are no serviceable parts in the equipment and no component substitution is permitted.

**Warning:** To prevent ignition of the explosive atmospheres, disconnect power before servicing and do not separate connectors, install or remove module from Power Rail when energized and an explosive gas mixture is present.

**Avertissement :** Pour éviter l'inflammation d'atmosphères explosibles, déconnectez l'alimentation avant les opérations d'entretien. Ne montez pas ou n'enlevez pas les connecteurs quand le module est sous tension et en présence d'un mélange de gaz. Ne montez pas ou n'enlevez pas les modules du rail d'alimentation en présence d'un mélange de gaz.

**Warning:** The Loop Supply and Current Input terminals for the same channel shall not be applied at the same time. The wiring of unused terminals is not allowed.

**Avertissement :** Les bornes d'entrée pour l'alimentation de boucle et l'entrée courant pour la même voie ne doivent pas être utilisées en même temps. Le câblage des bornes inutilisées n'est pas permis.

**Installation notes 9106Bxx:**

Associated Equipment /Appareillage Associé [Ex ia]

The output current of this associated apparatus is limited by a resistor such that the output voltage-current plot is a straight line drawn between open-circuit voltage and short-circuit current.

Selected intrinsically safe equipment must be third party listed as intrinsically safe for the application, and have intrinsically safe entity parameters conforming with Table 1 below.

**TABLE 1:**

<u>I.S. Equipment</u>		<u>Associated Apparatus</u>
V max (or U <sub>i</sub> )	≥	V <sub>oc</sub> or V <sub>t</sub> (or U <sub>o</sub> )
I max (or I <sub>i</sub> )	≥	I <sub>sc</sub> or I <sub>t</sub> (or I <sub>o</sub> )
P max, P <sub>i</sub>	≥	P <sub>o</sub>
C <sub>i</sub> + C <sub>cable</sub>	≤	C <sub>a</sub> (or C <sub>o</sub> )
L <sub>i</sub> + L <sub>cable</sub>	≤	L <sub>a</sub> (or L <sub>o</sub> )

Revision date:  
2019-11-26

Version Revision  
V2 R0

Prepared by:  
PB

Page:  
2/8

**LERBAKKEN 10, 8410 RØNDE DENMARK**

The 9106B may also be connected to a simple apparatus as defined in Article 504.2 and installed and temperature classified in accordance with Article 504.10(D) of the National Electrical Code (ANSI/NFPA 70), or other local codes, as applicable.

Capacitance and inductance of the field wiring from the intrinsically safe equipment to the associated apparatus shall be calculated and must be included in the system calculations as shown in Table 1. Cable capacitance,  $C_{cable}$ , plus intrinsically safe equipment capacitance,  $C_i$  must be less than the marked capacitance,  $C_a$  (or  $C_o$ ), shown on any associated apparatus used. The same applies for inductance ( $L_{cable}$ ,  $L_i$  and  $L_a$  or  $L_o$ , respectively). Where the cable capacitance and inductance per foot are not known, the following values shall be used:  $C_{cable} = 60 \text{ pF/ft.}$ ,  $L_{cable} = 0.2 \text{ } \mu\text{H/ft.}$

Where multiple circuits extend from the same piece of associated apparatus, they must be installed in separate cables or in one cable having suitable insulation. Refer to Article 504.30(B) of the National Electrical Code (ANSI/NFPA 70) and Instrument Society of America Recommended Practice ISA RP12.06 for installing intrinsically safe equipment.

Intrinsically safe circuits must be wired and separated in accordance with Article 504.20 of the National Electrical Code (ANSI/NFPA 70) or other local codes, as applicable.

The 9106B has not been evaluated for use in combination with another associated apparatus.

For installations in which both the  $C_i$  and  $L_i$  of the intrinsically safe apparatus exceeds 1% of the  $C_a$  (or  $C_o$ ) and  $L_a$  (or  $L_o$ ) parameters of the associated apparatus (excluding the cable), then 50% of  $C_a$  (or  $C_o$ ) and  $L_a$  (or  $L_o$ ) parameters are applicable and shall not be exceeded. The reduced capacitance shall not be greater than  $1 \text{ } \mu\text{F}$  for Groups C and/or D, and  $600 \text{ nF}$  for Groups A and B. The values of  $C_a$  (or  $C_o$ ) and  $L_a$  (or  $L_o$ ) determined by this method shall not be exceeded by the sum of all of  $C_i$  plus cable capacitances and the sum of all of the  $L_i$  plus cable inductances in the circuit respectively.

**General:**
**Supply terminal (31,32)**

Voltage: 19.2 – 31.2VDC

**Status Relay. terminal (33,34)**

Voltage max. 125 Vac / 110 Vdc  
 Current max. 0.5 Aac / 0.3 Adc

**Class I Division 2 or  
 Zone 2 installation**

32 Vac / 32 Vdc  
 0.5 Aac / 0.3 Adc

LERBAKKEN 10, 8410 RØNDE DENMARK

**Hazardous Classified Location**

Class I/II/III, Division 1, Group A,B,C,D,E,F,G  
Zone 0,1, 2 Group IIC, IIB, IIA or  
Zone 20, 21

**Unclassified Location or  
Hazardous Classified Location**

Class I, Division 2, Group ABCD T4  
Class I Zone 2 Group IIC T4

Simple Apparatus or  
Intrinsic safe apparatus  
with entity parameters:

$V_{max}(U_i) \geq V_t(U_o)$   
 $I_{max}(I_i) \geq I_t(I_o)$   
 $P_i \geq P_t(P_o)$   
 $C_a \geq C_{cable} + C_i$   
 $L_a \geq L_{cable} + L_i$

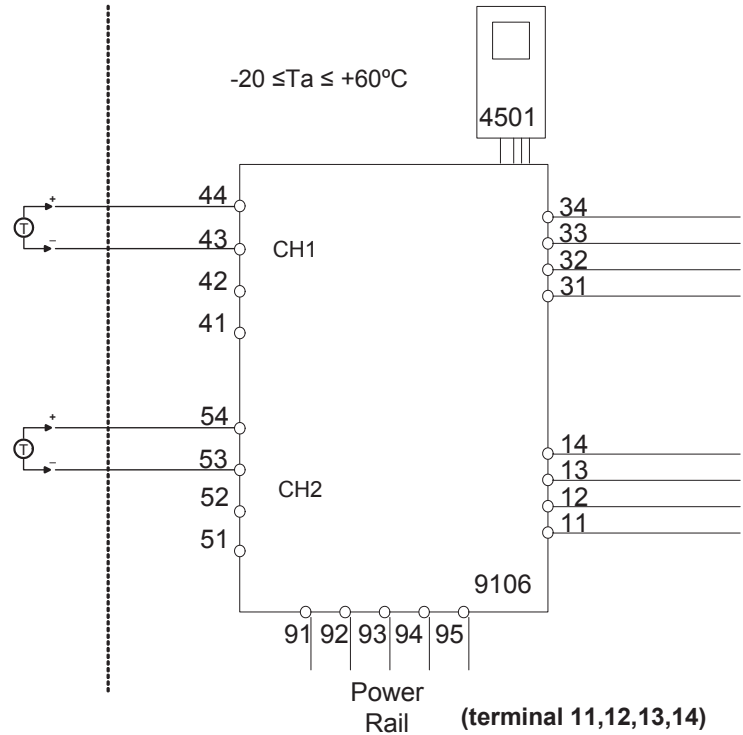

(terminal 11,12,13,14)  
(terminal 31,32,33,34)  
(terminal 91,92,93,94,95)  
 $U_m$ : 253V, max 400Hz

**9106B1A, 9106B1B**

**Ex input : Loop current source**

**CH1 (terminal 43,44)**

**CH2 (terminal 53,54)**

Voc or  $U_o$ : 27.5 Vdc

Isc or  $I_o$ : 92.6 mA

$P_o$ : 0.64 W

	IICor A,B	IIB or C,E,F	IIA or D, G
$C_a$ or $C_o$	0.084μF	0.670μF	2.23 μF
$L_a$ or $L_o$	4.15 mH	16.59 mH	33.17 mH
$L_o/R_o$	-----	223 μH/Ω	447 μH/Ω

**9106B2A, 9106B2B**

**Ex input : Loop current source**

**CH1 (terminal 43,44)**

**CH2 (terminal 53,54)**

Voc or  $U_o$ : 25.3 V

Isc or  $I_o$ : 96 mA

$P_o$ : 0.61 W

	IIC or A,B	IIB or C,E,F	IIA or D, G
$C_a$ or $C_o$	0.104μF	0.818μF	2.85 μF
$L_a$ or $L_o$	3.86 mH	15.43 mH	30.86 mH
$L_o/R_o$	-----	234 μH/Ω	468 μH/Ω

LERBAKKEN 10, 8410 RØNDE DENMARK

**Hazardous Classified Location**

Class I/II/III, Division 1, Group A,B,C,D,E,F,G  
Zone 0,1, 2 Group IIC, IIB, IIA or  
Zone 20, 21

**Unclassified Location or  
Hazardous Classified Location**

Class I, Division 2, Group ABCD T4  
Class I Zone 2 Group IIC T4

Simple Apparatus or  
Intrinsic safe apparatus  
with entity parameters:

$V_{max}(U_i) \geq V_t(U_o)$   
 $I_{max}(I_i) \geq I_t(I_o)$   
 $P_i \geq P_t(P_o)$   
 $C_a \geq C_{cable} + C_i$   
 $L_a \geq L_{cable} + L_i$

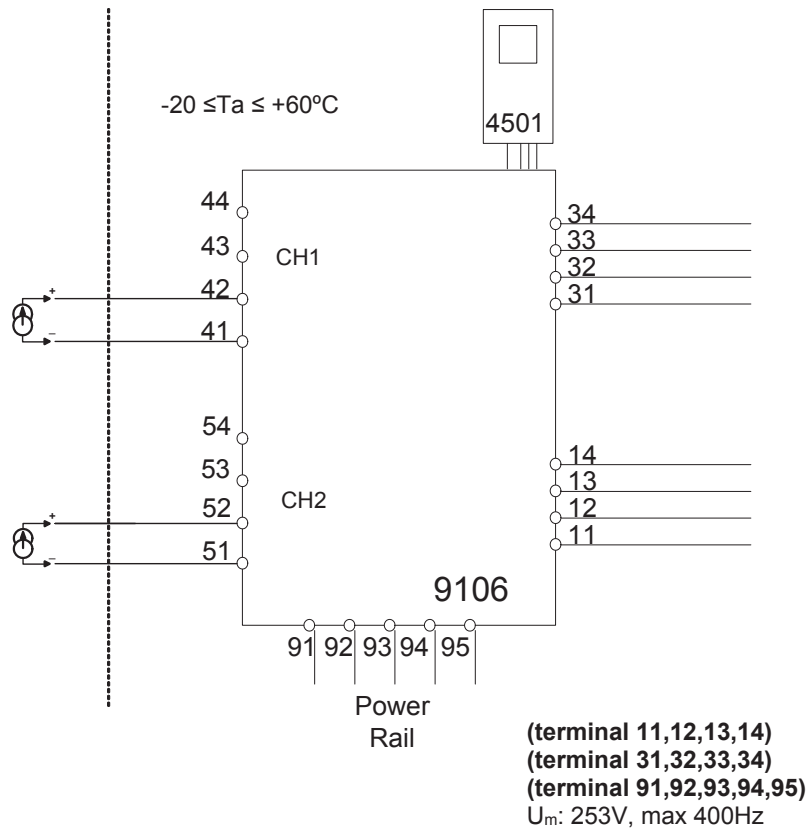

**9106B1A, 9106B1B, 9106B2A, 9106B2B**

**Ex input : External current source**

**CH1 (terminal 41,42)**

**CH2 (terminal 51,52)**

$V_{oc}$  or  $U_o$ : 0 V  
 $I_{sc}$  or  $I_o$ : 0 mA  
 $P_o$ : 0 mW

$V_{max}$  or  $U_i$ : 30 V  
 $I_{max}$  or  $I_i$ : 120 mA  
 $P_{max}$  or  $P_i$ : 0.85 W  
 $C_i$ : 2 nF  
 $L_i$ : 0 μH



LERBAKKEN 10, 8410 RØNDE DENMARK

**Hazardous Classified Location**

Class I/II/III, Division 1, Group A,B,C,D,E,F,G  
Zone 0,1, 2 Group IIC, IIB, IIA or  
Zone 20, 21

**Unclassified Location or**

**Hazardous Classified Location**  
Class I, Division 2, Group ABCD T4  
Class I Zone 2 Group IIC T4

Simple Apparatus or  
Intrinsic safe apparatus  
with entity parameters:

$V_{max}(U_i) \geq V_t(U_o)$   
 $I_{max}(I_i) \geq I_t(I_o)$   
 $P_i \geq P_t(P_o)$   
 $C_a \geq C_{cable} + C_i$   
 $L_a \geq L_{cable} + L_i$

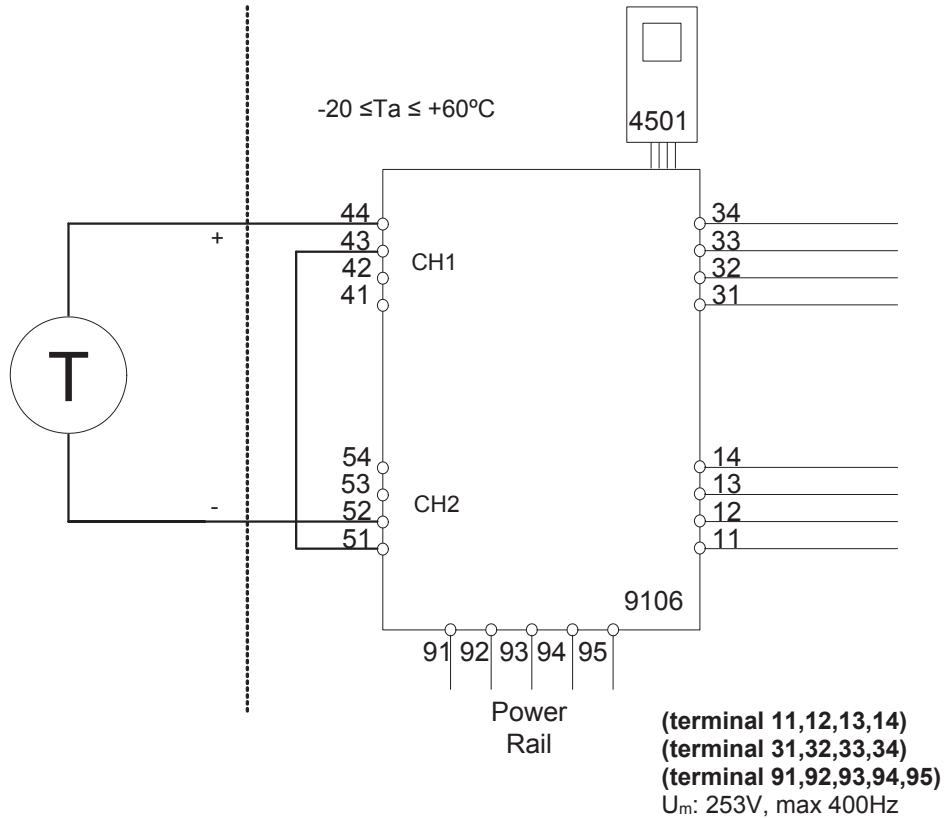

**9106B1A, 9106B1B**

**Ex input: Loop current source 1 to 2**  
**CH1 (terminal 44)**  
**CH2 (terminal 52)**

Voc or U<sub>o</sub>: 27.5 V  
Isc or I<sub>o</sub>: 92.6 mA  
P<sub>o</sub>: 0.64 W

	IIC or A,B	IIB or C,E,F	IIA or D,G
<b>Ca or Co.</b>	0.084µF	0.670µF	2.23 µF
<b>La or Lo.</b>	4.15 mH	16.59 mH	33.17 mH
<b>Lo/ Ro</b>	-----	223 µH/Ω	447 µH/Ω

**9106B2A, 9106B2B**

**Ex input: Loop current source 1 to 2**  
**CH1 (terminal 44)**  
**CH2 (terminal 52)**

Voc or U<sub>o</sub>: 25,3 V  
Isc or I<sub>o</sub>: 96 mA  
P<sub>o</sub>: 0.61 W

	IIC or A,B	IIB or C,E,F	IIA or D,G
<b>Ca or Co.</b>	0.104µF	0.818µF	2.85 µF
<b>La or Lo.</b>	3.86 mH	15.43 mH	30.86 mH
<b>Lo/ Ro</b>	-----	234 µH/Ω	468 µH/Ω

LERBAKKEN 10, 8410 RØNDE DENMARK

**Hazardous Classified Location**

Class I/II/III, Division 1, Group A,B,C,D,E,F,G  
Zone 0,1, 2 Group IIC, IIB, IIA or  
Zone 20, 21

**Unclassified Location or  
Hazardous Classified Location**

Class I, Division 2, Group ABCD T4  
Class I Zone 2 Group IIC T4

Simple Apparatus or  
Intrinsic safe apparatus  
with entity parameters:

$V_{max} (U_i) \geq V_t (U_o)$   
 $I_{max} (I_i) \geq I_t (I_o)$   
 $P_i \geq P_t (P_o)$   
 $C_a \geq C_{cable} + C_i$   
 $L_a \geq L_{cable} + L_i$

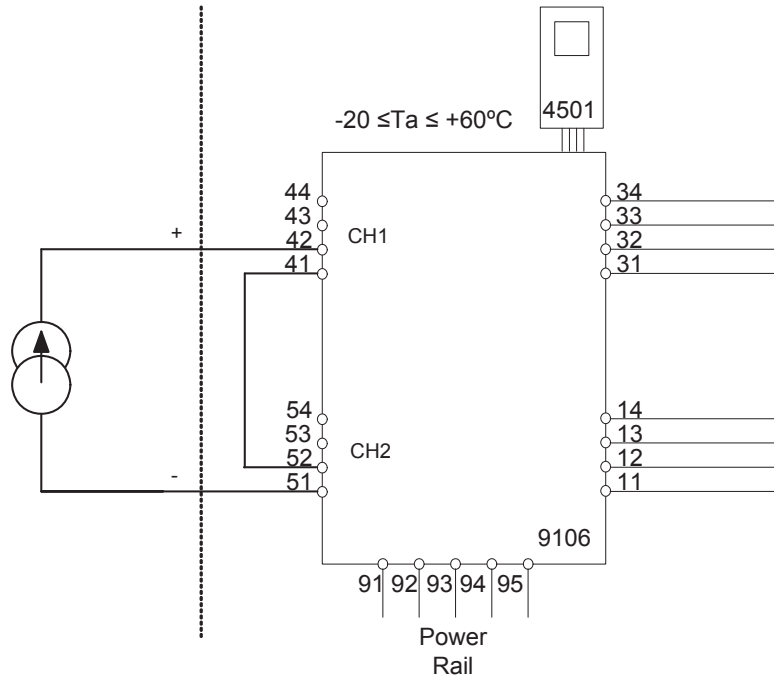

**9106B1A, 9106B1B, 9106B2A, 9106B2B**  
**Ex input : External current source 1 to 2**  
**CH1 (terminal 42)**  
**CH2 (terminal 51)**  
Voc or U<sub>o</sub>: 0 V  
Isc or I<sub>o</sub>: 0 mA  
P<sub>o</sub>: 0 W

**(terminal 11,12,13,14)**  
**(terminal 31,32,33,34)**  
**(terminal 91,92,93,94,95)**  
U<sub>m</sub>: 253V, max 400Hz

V<sub>max</sub> or U<sub>i</sub>: 30 V  
I<sub>max</sub> or I<sub>i</sub>: 120 mA  
P<sub>max</sub> or P<sub>i</sub>: 0.85 W  
C<sub>i</sub>: 4 nF  
L<sub>i</sub>: 0 μH

9106Axx Installation:

**Unclassified Location or  
Hazardous Classified Location**  
Class I, Division 2 Group A,B,C,D T4  
Class I, Zone 2, Group IIC, IIB, IIA T4

**Supply terminal (31,32)**  
Voltage: 19.2 – 31.2 VDC

**Status relay, terminal (33,34)**  
**Class I Division 2 or  
Zone 2 installation:**  
Voltage max: 32 Vac/ 32 Vdc  
Current max: 0.5 Aac / 0.3 Adc

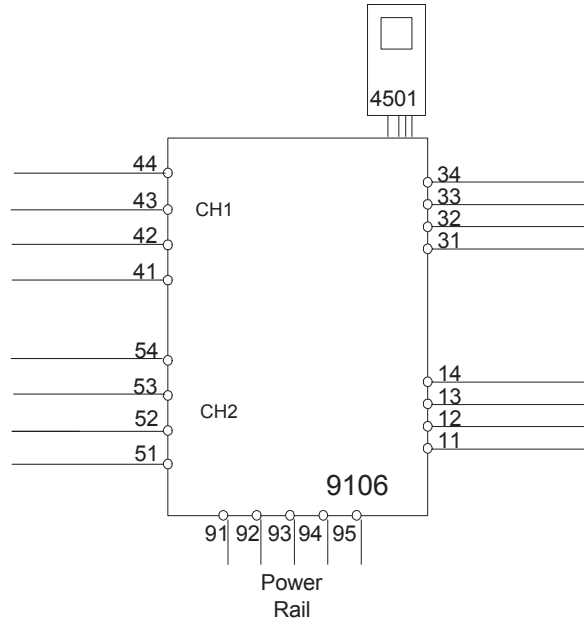

## INMETRO - Desenhos para Instalação



Para instalação segura do 9106B o manual seguinte deve ser observado. O módulo deve ser instalado somente por profissionais qualificados que estão familiarizados com as leis nacionais e internacionais, diretrizes e normas que se aplicam a esta área. Ano de fabricação pode ser obtido a partir dos dois primeiros dígitos do número de série.



Para a instalação na Zona 2 o seguinte deve ser observado. O módulo de programação de 4501, deve ser utilizado apenas com os módulos PRelectronics. É importante que o módulo esteja intacto e não tenha sido alterado ou modificado de qualquer maneira. Apenas os módulos 4501 livres de poeira e umidade devem ser instalados.

9106B1A: 1 canal HART®-repetidor transparente (Barreira 27,5 V)  
 9106B1B: 2 canais HART®- repetidor transparente (Barreira 27,5 V)  
 9106B2A: 1 canal HART®- repetidor transparente (Barreira 25,3 V)  
 9106B2B: 2 canais HART®- repetidor transparente (Barreira 25,3 V)

INMETRO Certificado ..... DEKRA 16.0001X

**Marcas** [Ex ia Ga] IIC/IIB/IIA  
 Ex nA nC IIC T4 Gc  
 [Ex ia Da] IIIC  
 [Ex ia Ma] I

**Normas:** ABNT NBR IEC 60079-0:2013, ABNT NBR IEC60079-11:2013,  
 ABNT NBR IEC60079-15:2012

**Terminais de alimentação** (31,32)  
 Voltagem: 19,2 – 31,2VDC

<b>Relé de estado terminais</b> (33,34)		Instalação Zone 2
Voltagem máx.:	125 VAC / 110 VDC	32 VAC / 32 VDC
Potência máx.:	62,5 VA / 32 W	16 VA / 32 W
Corrente máx.:	0,5 A AC / 0,3 ADC	0,5 A AC / 1 ADC

### Notas de Instalação:

Instalação em grau de poluição 2, categoria de sobretensão II conforme definido no IEC 60664-1  
 Não separe conectores quando energizado ou quando uma mistura de gás explosivo estiver presente.

Não monte ou remova módulos do trilho de alimentação quando uma mistura explosiva de gás estiver presente.

Desligue a alimentação antes da manutenção.

A fiação de terminais sem uso não é permitida.

A fonte de Loop e terminais de entrada de corrente para o mesmo canal não deve ser aplicada ao mesmo tempo.

Em tipo de proteção [Ex ia Da] os parâmetros para a segurança intrínseca para grupo de gás IIB são aplicáveis.

Para a instalação em Zona 2, o módulo deve ser instalado em um invólucro certificado conforme as normas da série ABNT NBR IEC 60079 que proporcione um grau de proteção de pelo menos IP54. Dispositivos de entrada de cabo e elementos de vedação devem cumprir com os mesmos requisitos.

Para a instalação de trilho de energia na Zona 2, apenas o trilho de alimentação Rail 9400 fornecido pela Unidade de Controle de Potência 9410 é permitido.

LERBAKKEN 10, 8410 RØNDE DENMARK

 Área de Risco  
 Zona 0,1,2, 20, 21, 22

 Área de não Risco  
 ou Zona 2

$$-20 \leq T_a \leq +60^\circ\text{C}$$

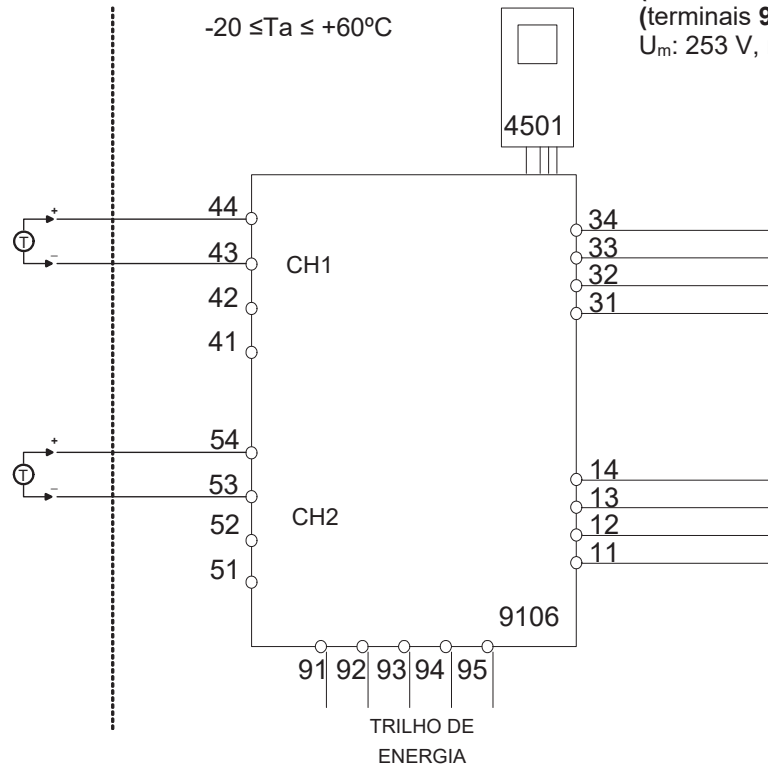
 (terminais 11,12,13,14)  
 (terminais 31,32,33,34)  
 (terminais 91,92,93,94,95)  
 $U_m: 253 \text{ V, máx. } 400 \text{ Hz}$ 

**9106B1A, 9106B1B**
**Entrada Ex: Fonte de corrente da malha**  
**CN1 (terminais 43,44)**  
**CN2 (terminais 53,54)**
 $U_o: 27,5 \text{ V}$   
 $I_o: 92,6 \text{ mA}$   
 $P_o: 0,65 \text{ W}$ 
**9106B2A, 9106B2B**
**Entrada Ex: Fonte de corrente da malha**  
**CN1 (terminais 43,44)**  
**CN2 (terminais 53,54)**
 $U_o: 25,3 \text{ V}$   
 $I_o: 96 \text{ mA}$   
 $P_o: 0,61 \text{ W}$ 

	IIC	IIB	IIA	I
$C_o$	0,084 $\mu\text{F}$	0,670 $\mu\text{F}$	2,23 $\mu\text{F}$	3,94 $\mu\text{F}$
$L_o$	4,15 mH	16,59 mH	33,17 mH	54,42 mH
$L_o/R_o$	-----	223 $\mu\text{H}/\Omega$	447 $\mu\text{H}/\Omega$	733 $\mu\text{H}/\Omega$

	IIC	IIB	IIA	I
$C_o$	0,104 $\mu\text{F}$	0,818 $\mu\text{F}$	2,85 $\mu\text{F}$	4,74 $\mu\text{F}$
$L_o$	3,86 mH	15,43 mH	30,86 mH	50,64 mH
$L_o/R_o$	-----	234 $\mu\text{H}/\Omega$	468 $\mu\text{H}/\Omega$	769 $\mu\text{H}/\Omega$

LERBAKKEN 10, 8410 RØNDE DENMARK

Área de Risco  
Zona 0,1,2, 20, 21, 22

Área de não Risco  
ou Zona 2

$-20 \leq T_a \leq +60^\circ\text{C}$

(terminais 11,12,13,14)  
(terminais 31,32,33,34)  
(terminais 91,92,93,94,95)  
 $U_m$ : 253 V, máx. 400 Hz

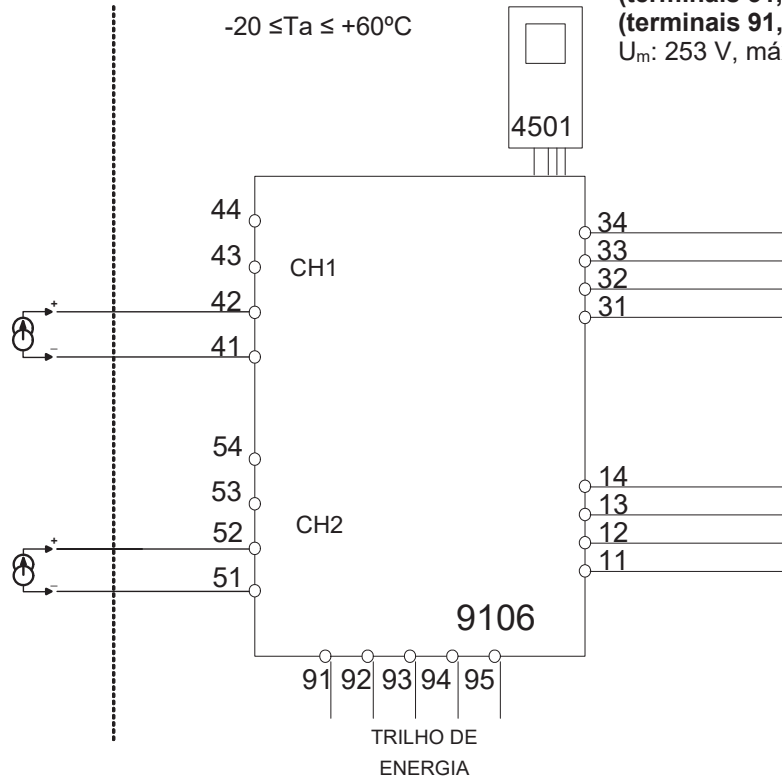

**9106B1A, 9106B1B, 9106B2A, 9106B2B**

**Entrada Ex: Fonte de corrente externa**

**CN1 (terminal 41,42)**

**CN2 (terminal 51,52)**

$U_o$ : 0 V  
 $I_o$ : 0 mA  
 $P_o$ : 0 mW

$U_i$ : 30 V  
 $I_i$ : 120 mA  
 $P_i$ : 0,85 W  
 $C_i$ : 2 nF  
 $L_i$ : 0  $\mu\text{H}$

LERBAKKEN 10, 8410 RØNDE DENMARK

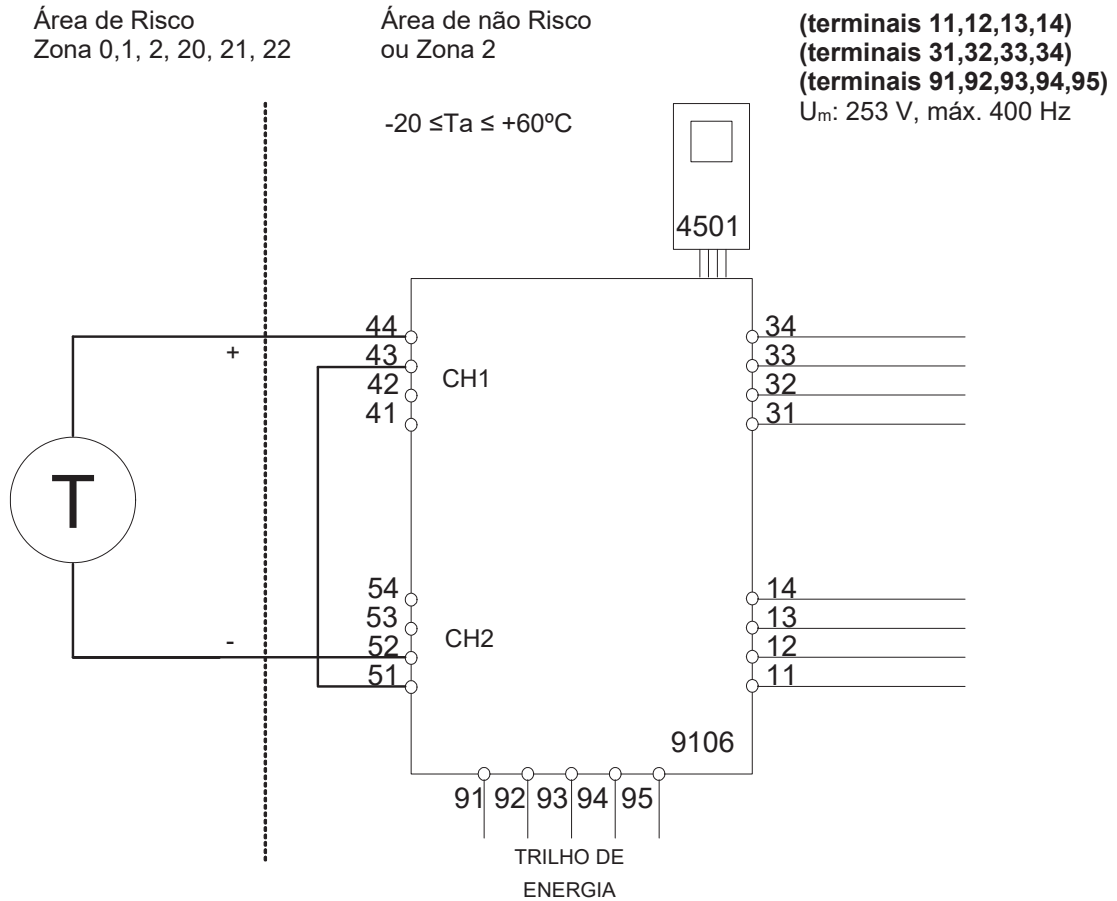
**9106B1A, 9106B1B**
**Entrada Ex: fonte de corrente da malha 1 e 2**
**CN1 (terminal 44)**
**CN2 (terminal 52)**
 $U_o:$  27,5 V

 $I_o:$  92,6 mA

 $P_o:$  0,64 W

**9106B2A, 9106B2B**
**Entrada Ex: fonte de corrente da malha 1 e 2**
**CN1 (terminal 44)**
**CN2 (terminal 52)**
 $U_o:$  25,3 V

 $I_o:$  96 mA

 $P_o:$  0,61 W

	IIC	IIB	IIA	I
$C_o$	0,084 $\mu$ F	0,670 $\mu$ F	2,23 $\mu$ F	3,94 $\mu$ F
$L_o$	4,15 mH	16,59 mH	33,17 mH	54,42 mH
$L_o/R_o$	-----	223 $\mu$ H/ $\Omega$	447 $\mu$ H/ $\Omega$	733 $\mu$ H/ $\Omega$

	IIC	IIB	IIA	I
$C_o$	0,104 $\mu$ F	0,818 $\mu$ F	2,85 $\mu$ F	4,74 $\mu$ F
$L_o$	3,86 mH	15,43 mH	30,86 mH	50,64 mH
$L_o/R_o$	-----	234 $\mu$ H/ $\Omega$	468 $\mu$ H/ $\Omega$	769 $\mu$ H/ $\Omega$

LERBAKKEN 10, 8410 RØNDE DENMARK

Área de Risco  
Zona 0,1,2, 20, 21, 22

Área de não Risco  
ou Zona 2

$-20 \leq T_a \leq +60^\circ\text{C}$

(terminais 11,12,13,14)  
(terminais 31,32,33,34)  
(terminais 91,92,93,94,95)  
 $U_m: 253 \text{ V, máx. } 400 \text{ Hz}$

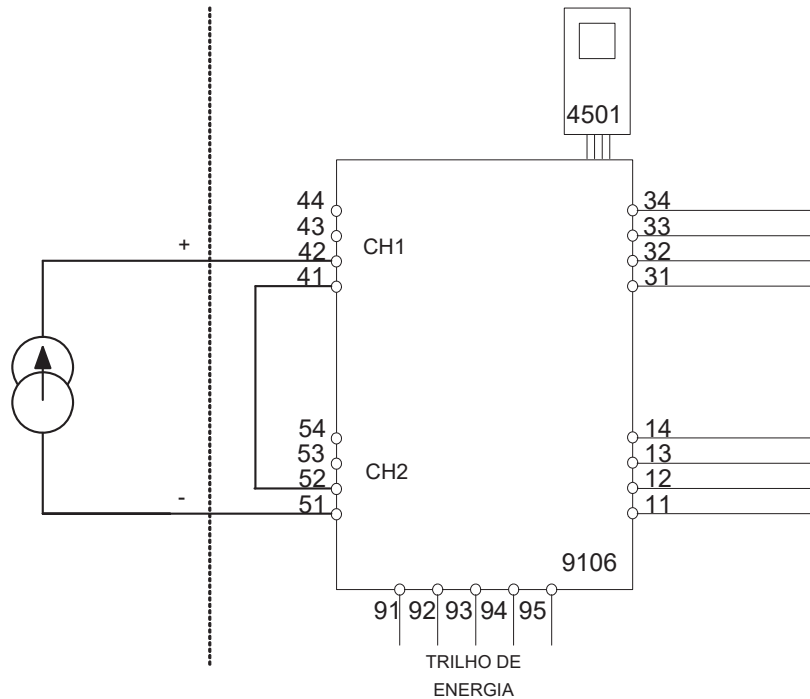

**9106B1A, 9106B1B, 9106B2A, 9106B2B**  
**Entrada Ex: Fonte de corrente externa 1 a 2**

**CN1 (terminal 42)**

**CN2 (terminal 51)**

$U_o: 0 \text{ V}$   
 $I_o: 0 \text{ mA}$   
 $P_o: 0 \text{ W}$

$U_i: 30 \text{ V}$   
 $I_i: 120 \text{ mA}$   
 $P_i: 0,85 \text{ W}$   
 $C_i: 4 \text{ nF}$   
 $L_i: 0 \mu\text{H}$



## Document history

The following list provides notes concerning revisions of this document.

<b>Rev. ID</b>	<b>Date</b>	<b>Notes</b>
105	1703	Installation drawings updated Ex barrier data changed
106	1931	Specifications for max. required power added 9106A-version included in manual Variant with UL 913 approval added CCOE approval discontinued

# We are near you, *all over the world*

**Our trusted red boxes are supported wherever you are**

All our devices are backed by expert service and a 5-year warranty. With each product you purchase, you receive personal technical support and guidance, day-to-day delivery, repair without charge within the warranty period and easily accessible documentation.

We are headquartered in Denmark, and have offices and authorized partners the world over. We are a local

business with a global reach. This means that we are always nearby and know your local markets well. We are committed to your satisfaction and provide PERFORMANCE MADE SMARTER all around the world.

For more information on our warranty program, or to meet with a sales representative in your region, visit [prelectronics.com](http://prelectronics.com).

# Benefit today from *PERFORMANCE MADE SMARTER*

PR electronics is the leading technology company specialized in making industrial process control safer, more reliable and more efficient. Since 1974, we have been dedicated to perfecting our core competence of innovating high precision technology with low power consumption. This dedication continues to set new standards for products communicating, monitoring and connecting our customers' process measurement points to their process control systems.

Our innovative, patented technologies are derived from our extensive R&D facilities and from having a great understanding of our customers' needs and processes. We are guided by principles of simplicity, focus, courage and excellence, enabling some of the world's greatest companies to achieve PERFORMANCE MADE SMARTER.